



DIGITALINX  
BY LIBERTY AV SOLUTIONS

## DL-SC31U-BX Owners Manual



**TeamUp+**

A/V and USB Auto Switchers

## Important Safety Instructions

- » Please completely read and verify you understand all instructions in this manual before operating this equipment.
- » Keep these instructions in a safe, accessible place for future reference.
- » Heed all warnings.
- » Follow all instructions.
- » Do not use this apparatus near water.
- » Clean only with a dry cloth.
- » Do not install near any heat sources such as radiators, heat registers, stoves, or other apparatus (including amplifiers) that produce heat.
- » Use only accessories specified or recommended by Intelix.
- » Explanation of graphical symbols:

◊ Lightning bolt/flash symbol: the lightning bolt/flash and arrowhead within an equilateral triangle symbol is intended to alert the user to the presence of uninsulated “dangerous voltage” within the product enclosure which may be of sufficient magnitude to constitute a risk of shock to a person or persons.



◊ Exclamation point symbol: the exclamation point within an equilateral triangle symbol is intended to alert the user to the presence of important operating and maintenance (servicing) instructions in the literature accompanying the product.



- » **WARNING: TO REDUCE THE RISK OF FIRE OR ELECTRIC SHOCK, DO NOT EXPOSE THIS APPARATUS TO RAIN OR MOISTURE AND OBJECTS FILLED WITH LIQUIDS, SUCH AS VASES, SHOULD NOT BE PLACED ON THIS APPARATUS.**
- » Use the mains plug to disconnect the apparatus from the mains.
- » **THE MAINS PLUG OF THE POWER CORD MUST REMAIN READILY ACCESSIBLE.**
- » Do not defeat the safety purpose polarized or grounding-type plug. A polarized plug has two blades with one wider than the other. A grounding-type plug has two blades and a third grounding prong. The wide blade or the third prong is provided for your safety. If the provided plug does not fit into your outlet, consult an electrician for replacement of your obsolete outlet. **Caution! To reduce the risk of electrical shock, grounding of the center pin of this plug must be maintained.**
- » Protect the power cord from being walked on or pinched particularly at the plugs, convenience receptacles, and the point where they exit from the apparatus.
- » Do not block the air ventilation openings. Only mount the equipment per Intelix’s instructions.
- » Use only with the cart, stand, table, or rack specified by Intelix or sold with the equipment. When/if a cart is used, use caution when moving the cart/equipment combination to avoid injury from tip-over.
- » Unplug this apparatus during lightning storms or when unused for long periods of time.
- » **Caution! Shock Hazard. Do not open the unit.**
- » Refer to qualified service personnel. Servicing is required when the apparatus has been damaged in any way, such as power supply cord or plug is damaged, liquid has been spilled or objects have fallen into the apparatus, the apparatus has been exposed to rain or moisture, does not operate normally, or has been dropped.



# Table of Contents

<b>Product Overview</b> .....	4
<b>Product Contents</b> .....	4
<b>Top and Bottom Panels</b> .....	5
<i>Top Panel</i> .....	5
<i>Bottom Panel</i> .....	6
<b>Installation Instructions</b> .....	7
<i>Install Table Pocket</i> .....	7
<i>Connect A/V Sources</i> .....	7
Video Inputs.....	7
<i>Connect Display</i> .....	8
HDMI Output.....	8
<i>Connect USB Hosts / Devices</i> .....	8
Host Inputs.....	8
Device Inputs.....	8
<i>Connecting Control</i> .....	9
RS232 Port Wiring.....	9
<i>Connect Ethernet (Web Browser) Control (Optional)</i> .....	10
Router Connection.....	10
Web Browser Control.....	10
<i>Applying Power</i> .....	10
<b>A/V Diagram</b> .....	11
<b>Web GUI Control / System Settings</b> .....	12
<i>Switcher Control</i> .....	12
Connecting to Web GUI Control.....	12
A/V Switching.....	13
RS232 Display Control Settings.....	14
Auto Display ON/OFF Settings.....	15
USB Host Switching Settings.....	16
Edid Management.....	17
Renaming Inputs.....	18
Network Settings.....	19
Security Settings.....	20
System Settings.....	21
<b>RS232 and TCP/IP Control</b> .....	22
<i>A/V Routing</i> .....	22
<i>USB Host Routing</i> .....	23
<i>CEC / RS232 Display Control</i> .....	24
<i>System Commands</i> .....	25
<b>Technical Specifications</b> .....	26
<b>Device Dimensions</b> .....	27

## Product Overview

The DigitaLinx DL-SC31U-BX is a 3x1 multi format A/V and USB conference auto switcher and table pocket that supports video resolutions up to 4K@60Hz 4:4:4 8bit deep color and has a built in 4 port USB 3.x hub for integration of USB devices such as USB cameras and microphones that can be switched between three USB (PC) hosts. The switcher features three video inputs; (2) HDMI and (1) USB-C. The USB-C input supports video, data (USB host) and power charging up to 40w. The 4 port USB device hub (2 top and 2 bottom) can switch between the USB (PC) hosts automatically or can be assigned to follow a video input in auto switching mode so when the video input is triggered the corresponding USB host will switch as well.

The DL-SC31U-BX gives you the ability to automate the display power ON by using pre-loaded RS232 commands whenever a video signal is introduced to the system using any A/V input or by pressing the DISPLAY control button on the front panel. It will also turn the display power OFF after a specified amount of time has passed when no video signal or switching activity is present.

The DL-SC31U-BX can be controlled by API commands using RS232 or Ethernet. A web server / GUI is built in that features A/V and USB switching control, automatic display control and input EDID management.

The DL-SC31U-BX is ideal for software based video teleconference rooms that require the consolidation and sync of A/V and USB signals from a laptop or room PC.

## Product Contents

- DL-SC31U-BX 4X1 HDMI / USB Switcher
- (1) Cut out template
- (1) 3 pin Phoenix Male Connector
- (2) Table mounting screws clamps
- (1) Cable lacing bar with screws
- DC24V 5A Power Supply with US, UK, EU and AU adapter cables

## Top and Bottom Panels

### Top Panel

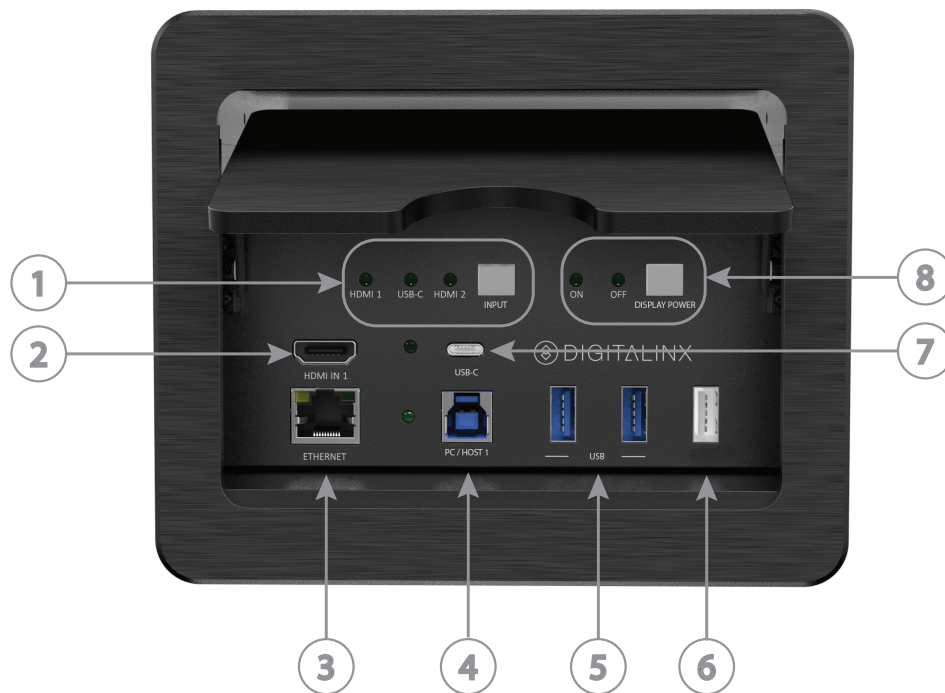

1. **INPUT LED'S AND SELECTOR**- A/V input source selector and corresponding LEDs
  - *INPUT* - Input selection button, hold down this button for 3 seconds to enter and exit automatic switching mode
2. **HDMI IN 1** - HDMI input 1
3. **ETHERNET** - RJ45 connector for Ethernet pass through (to ETHERNET on bottom panel)
4. **PC / HOST 1** - USB B Host port 1
5. **USB** - Two USB A device ports for USB audio and video devices
6. **Power** - USB A port for device charging only, provides up to 5 volts / 1 amp
7. **USB-C** - USB-C input, supports A/V, data and power charging up to 40 watts
 

**NOTE:** The DL-SC31U-BX USB-C input supports Display Port over Alternate mode for A/V and USB data, to ensure a source is compatible with the DL-SC31U-BX check the sources capability of supporting this mode. 40 watts of power is provided in USB-C connected device
8. **DISPLAY POWER** - Press this button to turn *on* or *off* the connected TV display, the corresponding LED *ON* or *OFF* will illuminate green confirming the display status. This function works with HDMI / CEC control as well as pre-loaded RS232 commands. RS232 commands can be configured in the web GUI settings, see page 14

## Bottom Panel

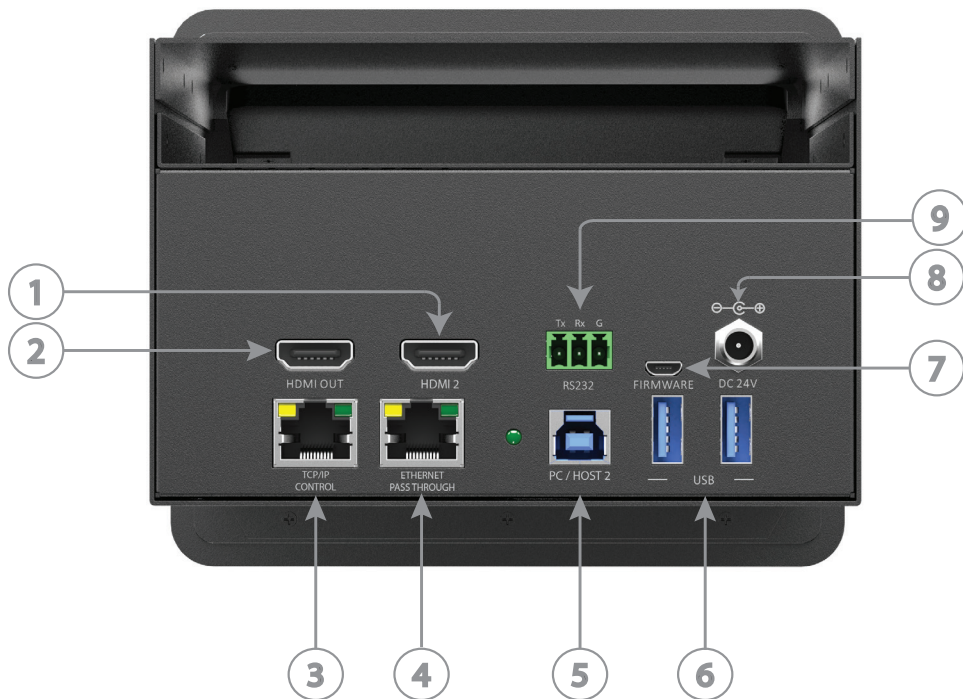

1. **HDMI 2** - HDMI input 2
2. **HDMI OUT** - HDMI output
3. **TCP/IP CONTROL** - RJ45 connector for Ethernet control and to access the internal web GUI
4. **ETHERNET PASS THROUGH** - RJ45 connector for Ethernet pass through (to ETHERNET on top panel)
5. **PC / HOST 2** - USB B Host port 2
6. **USB** - Two USB A device ports for USB audio and video devices
7. **FIRMWARE** - USB Micro port for performing device firmware updates
8. **DC24V** - Power supply input
9. **RS232** - Phoenix connector for RS232 system control or to control external TV display ON and OFF status with front panel display control button. RS232 commands for display control can be configured in the web GUI settings, see page 14.

# Installation Instructions

## ***Install Table Pocket***

A table cut out template has been provided in the package contents of the DL-SC31U-BX that is printed to the correct scale of the device dimensions.

Before cutting into the table top, confirm that the product you are installing is the DL-SC31U-BX as the provided template is only for this product. Cut out the 'surface cut-out area' from the template. Use the cut-out to mark the position on the table top where the device will be installed. Always measure twice and compare to product before making a cut into the table.

Install the table braces as shown below so table pocket switcher is mounted securely to conference table



## ***Connect A/V Sources***

### *Video Inputs*

Connect source devices to the HDMI, or USB-C inputs. When using HDMI cables for source inputs, use a High Speed HDMI cable that is less than or equal to 5 meters in length for 4k60 signals and 8 meters for 1080p signals.

When connecting a source device to the USB-C input using a USB-C cable, be sure the USB-C cable is capable of supporting video and is no longer than 2 meters (6.6') in total length. The DL-SC31U-BX USB-C input supports ALT-DP mode for audio, video data and power charging. To ensure a laptop is compatible with the DL-SC31U-BX check the laptops capability of supporting this mode.

***Note that not all laptops with USB-C port options will support video or more specifically ALT-DP video mode.***

**Note:** By default the video inputs will switch automatically sensing HDMI / USB-C voltage, to change switching mode to manual hold down the *INPUT* button for 3 seconds. The inputs can also be changed by web GUI settings and the API, see page 13 and 22

## **Connect Display**

### *HDMI Output*

Connect display device to the HDMI output using a High Speed HDMI cable that is less than or equal to 5 meters in length for 4k60 signals and 8 meters for 1080p signals.

## **Connect USB Hosts / Devices**

### *Host Inputs*

Connect a PC USB port to either the PC/HOST 1 or PC/HOST 2 (bottom) to connect to devices connected to the DL-SC31U-BX USB hub. When using USB cables for USB host inputs, use a high quality USB 3.x cable no longer than 5m or 16.4'. USB-C can also connect as the host, the USB-C host port supports USB 3.2 Gen1 up to 5Gbps. When using a USB-C cable be sure to use a 3.2 Gen1 USB cable.

**Note:** By default the hosts will switch to follow video input automatically, HDMI 1 is associated with PC/HOST 1, PC/HOST 2 is associated with HDMI 2 and USB-C to USB-C. To change this manually or by USB activity automatically, see page 16.

### *Device Inputs*

Connect a USB device to either the top or bottom USB devices ports. When using USB cables for 3.x USB devices, use a high quality USB 3.x cable no longer than 5m or 16.4'. For any length over this specification please use a USB extender.



### Connecting Control

#### RS232 Port Wiring

Connect a control system or display to the DL-SC31U-BX via RS232 for switcher control or for display control.

#### RS232 Wiring

Connect the system controller or display RX signal to TX on the DL-SC31U-BX, then connect the controllers TX signal to RX on the DL-SC31U-BX.

#### RS232 Settings:

- 9600 baud
- 8 Data Bits
- 1 Stop Bit
- Parity = none

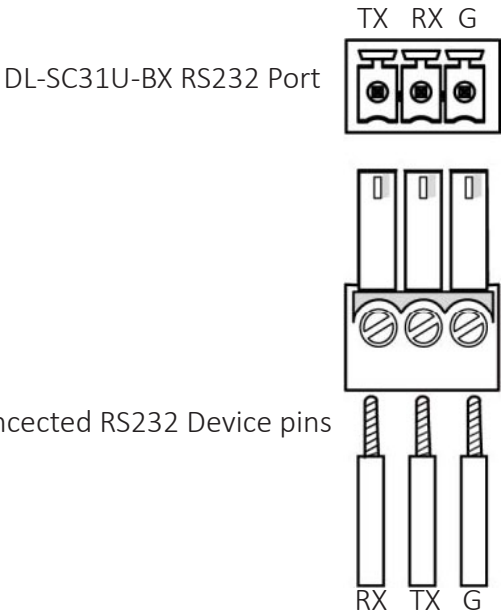

## Connect Ethernet (Web Browser) Control (Optional)

The DL-SC31U-BX can be controlled via Ethernet through a web browser interface.

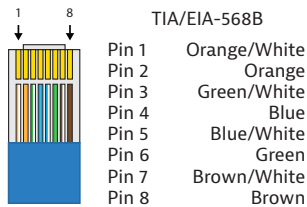

The TCP/IP port requires a standard straight-through Category 5 or greater cable with the TIA/EIA-568B crimp pattern for optimal operation.

The default settings for the TCP/IP port are:  
IP address: 192.168.0.178, Telnet Port 4001

Connect the Ethernet cable between to the switcher and a router with a straight-through cable or between the matrix and a computer with a crossover cable.

### Router Connection

1. Configure the router to use the same IP range as the matrix, such as 192.168.0.1.
2. Connect the computer to the router.
3. Connect the DL-SC31U-BX to the router

### Web Browser Control

The DL-SC31U-BX includes a web portal to allow control of the matrix via a standard web browser. The IP address is the same address that is used for TCP/IP control.

## Applying Power

Connect the included power supply to the DL-SC31U-BX power port, connect the IEC power cord connected to power supply to a power source.

# A/V Diagram

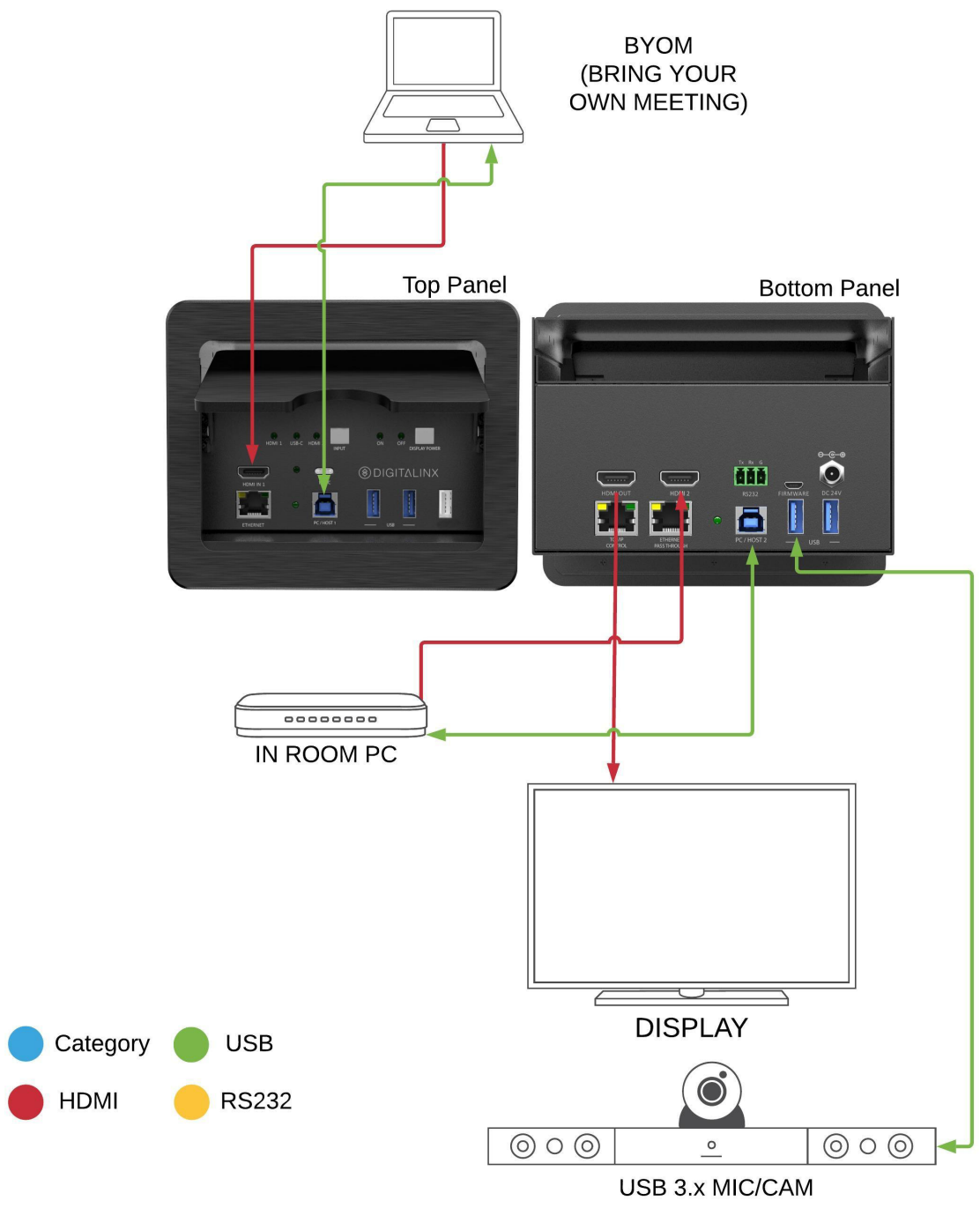

# Web GUI Control / System Settings

## **Switcher Control**

### *Connecting to Web GUI Control*

Network a PC computer and the DL-SC31U-BX then open a web browser and type in IP address of the DL-SC31U-BX . The default IP address is 192.168.0.178. Be sure the computer you are using to connect to the DL-SC31U-BX is in the same IP range to access the web GUI / server.

The login screen will appear. The default user name and password is *admin*

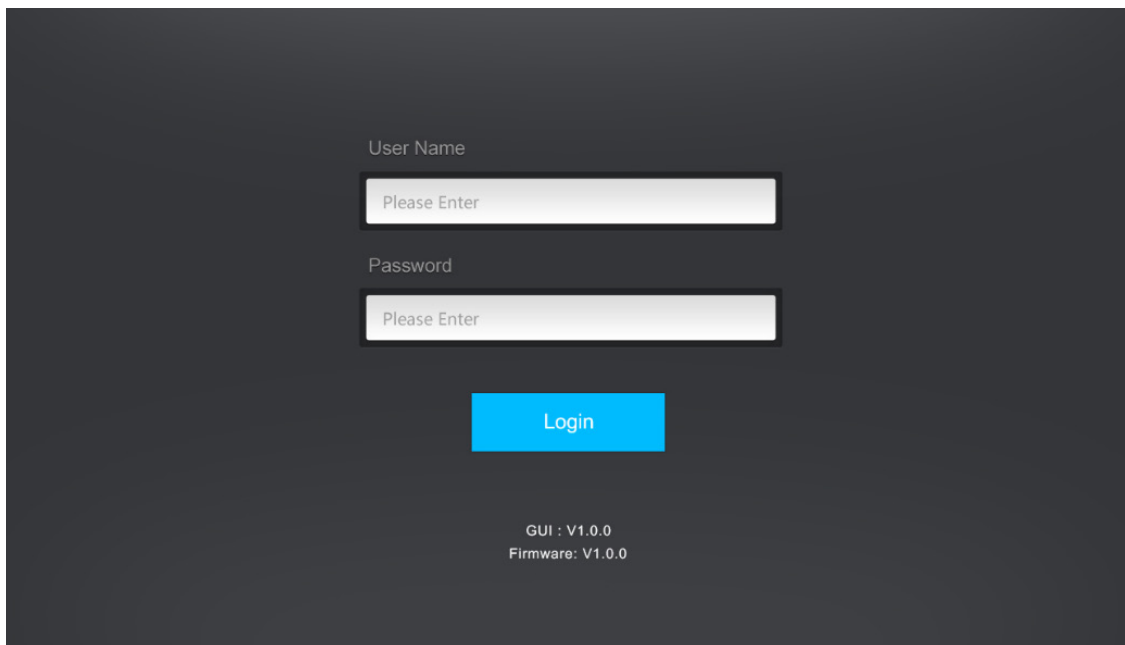

## A/V Switching

The *CONTROL* menu allows you to route A/V signals from the video inputs to the HDMI output of the switcher and enable / disable auto switching mode.

To enable / disable auto switching mode, check the *ON/OFF* button in the *Auto Switching* option. When auto switching is disabled, the switcher must be switched manually by either using the front panel buttons, the embedded web GUI or with the API. By default the DL-SC31U-BX is set to auto switching mode and follows the 'first in last out' method. To use *5V HDMI* or *A/V Signal Detection* for auto switching mode, check the desired button in the *Auto Switching* option, the setting will take immediately. By default auto switching is set to *5V HDMI* for the auto switching trigger.

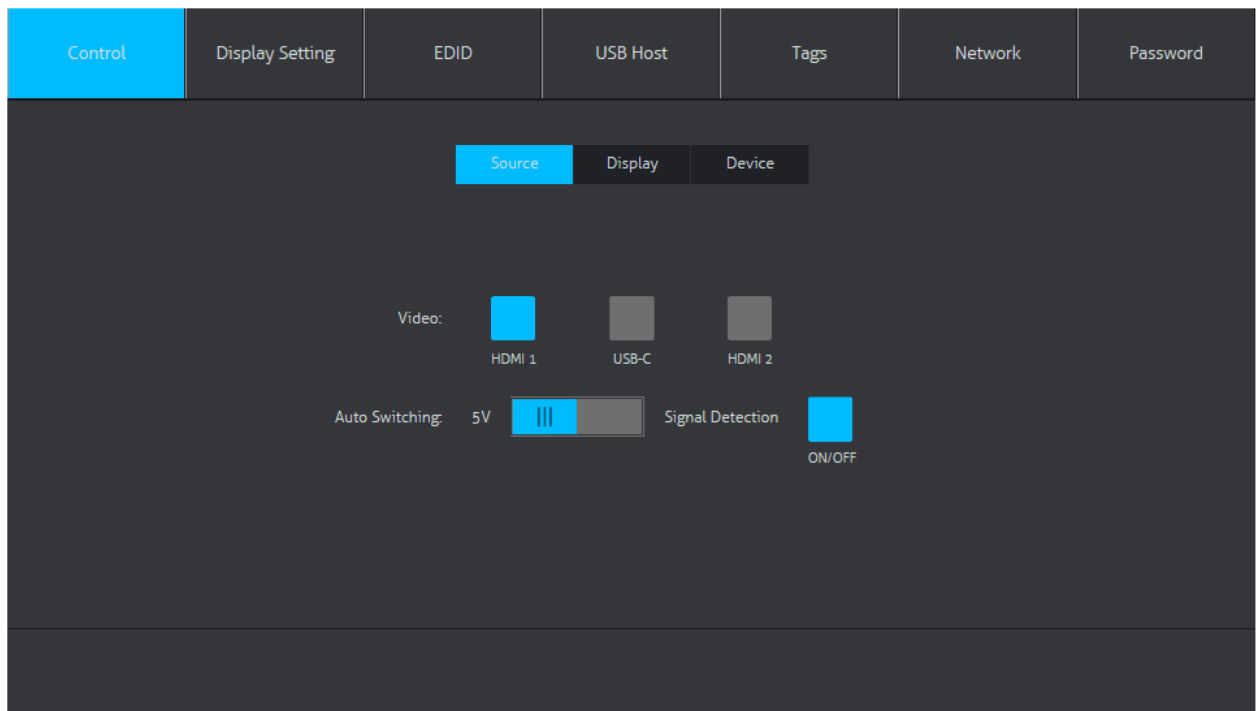

### RS232 Display Control Settings

The *Display Setting* menu allows you to configure RS232 serial strings to be transmitted to a connected display to the DL-SC31U-BX RS232 port. An RS232 / serial connection must be made from either device to a display for this option to work.

Refer to the projector or displays owners manual to obtain the RS232 / serial strings for control. You will want to locate the ON, OFF, and INPUT string for the device, what the default baud rating is for the serial connection on the display, what pins should be terminated for TX,RX and how the commands must be terminated i.e. carriage return, line feed etc. Be sure the TX, RX pins are appropriately connected from the display to the switcher. See page 9 for making a serial connection.

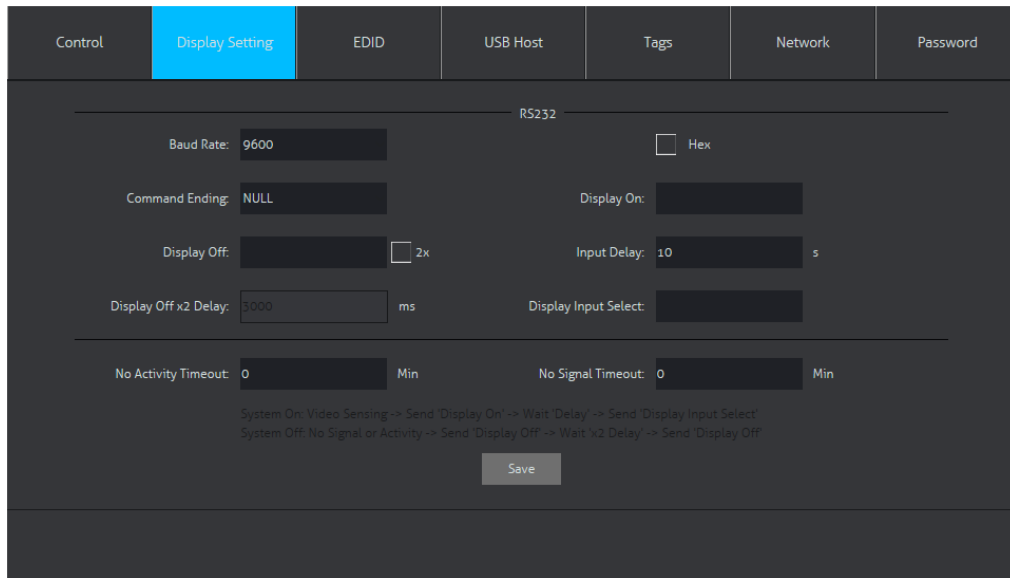

Enter baud rate of the display under *BAUD RATE*

Enter the string terminator under *COMMAND ENDING*

- *NULL*- None
- *CR*- Carriage Return
- *LF*- Line Feed
- *CR + LF* - Carriage Return + Line Feed

Enter the display ON string in the *DISPLAY ON* field

Enter the desired time delay in seconds in the *INPUT DELAY* field for the input command. The input command will be transmitted to the display after the input command has been generated.

Enter the desired display input string in the *DISPLAY INPUT SELECT* field

Enter the display OFF string in the *DISPLAY OFF* field, check the X2 box if the command must be repeated 2 times then enter the display off delay in seconds in the *DISPLAY OFF X2 DELAY* field.

Click *SAVE* to save settings

**NOTE:** The DISPLAY ON and OFF strings saved in this menu will be triggered manually with the DL-SC31U-BX front panel *DISPLAY POWER* button

### Auto Display ON/OFF Settings

The *DISPLAY SETTING > DISPLAY* menu allows you to enable / disable automatic display ON/OFF control.

When display control is ON, the DL-SC31U-BX can turn the display or projector ON using the stored RS232 commands previously set up in the *DISPLAY SETTING > RS232* menu or by CEC when an AV signal is introduced to either of the switchers inputs. When an AV signal is not present after a specified time, the DL-SC31U-BX can generate the saved RS232 OFF command as well as CEC to turn OFF the display or projector.

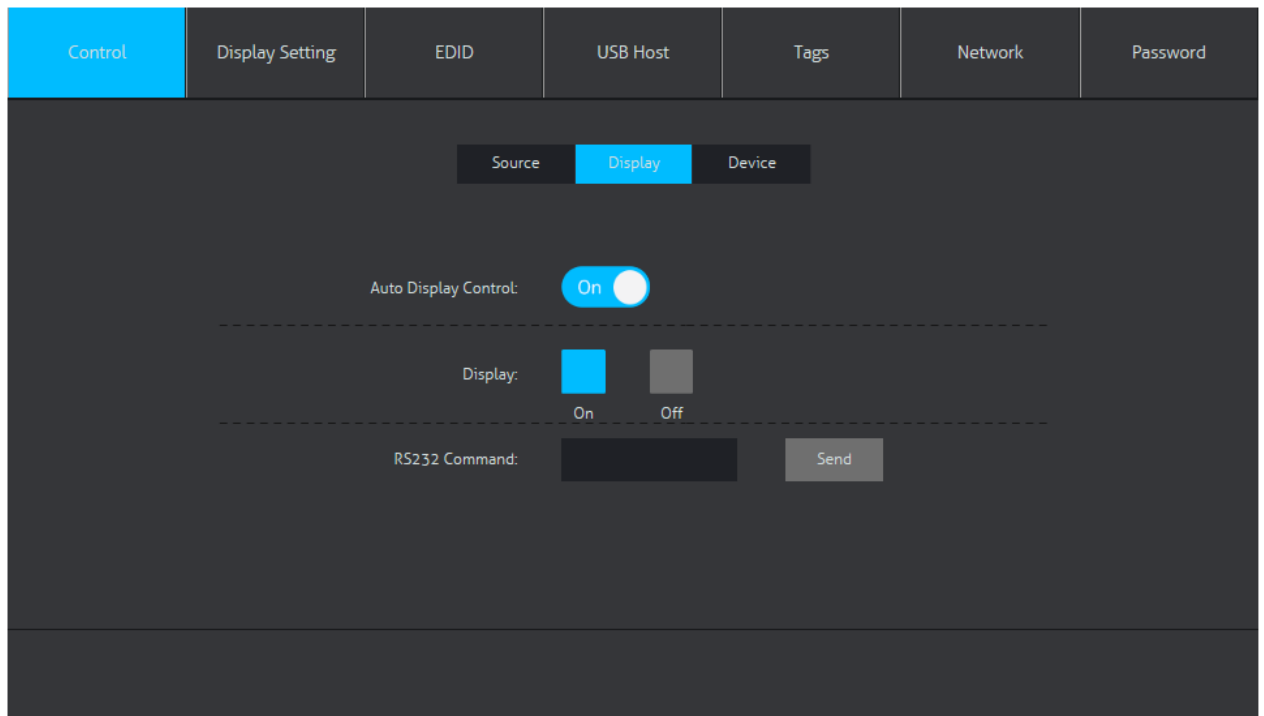

By default the *DISPLAY CONTROL* option is *ON*, press the ON toggle button to disable *DISPLAY CONTROL*

To set up the timeout parameters for turning the display OFF, navigate to *DISPLAY SETTING* page. Enter in the time in minutes in the *NO SIGNAL TIMEOUT* or *NO ACTIVITY* form, then press *SAVE*.

## USB Host Switching Settings

In the DL-SC31U-BX there are three USB hosts that can be switched either automatically, manually or they can be set to follow the video input automatically when the AV input is selected. By default, PC / HOST 1 USB host follows HDMI 1, PC / HOST 2 host follows HDMI 2 and when connecting USB C device it also switches to this input as a host.

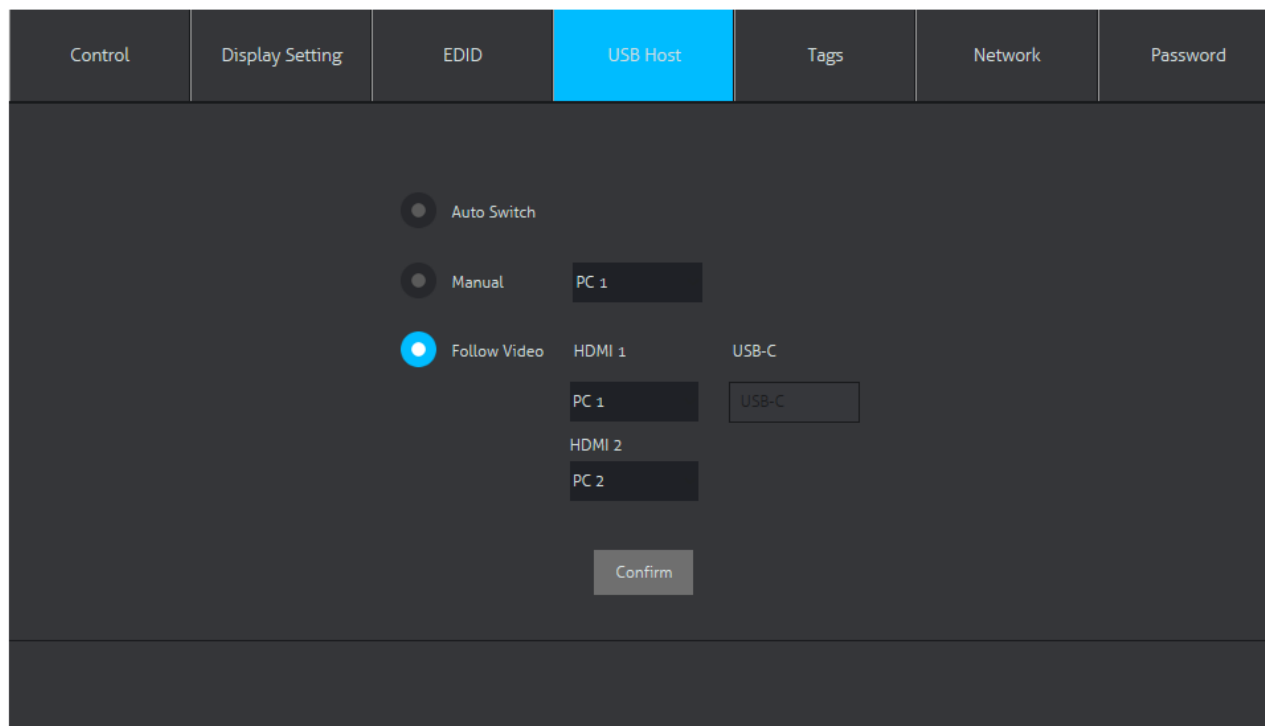

To change the USB hosts to switch automatically based on USB signal detection on either PC 1, PC 2 or USB C check the *AUTO SWITCH* option

To manually switch to the desired USB host check the *MANUAL* option and then choose which host to switch to PC1 or PC2.

To set a USB host to follow a selected video input, select *FOLLOW VIDEO* and use the drop down buttons to assign hosts to inputs. USB-C will always switch as the host when this input is selected

Press *CONFIRM* to save any settings



## Edid Management

EDID can be set for each A/V input using the *EDID* menu.

To adjust an inputs EDID option, click on the desired input channel then click on the desired resolution, then click *CONFIRM*.

When uploading a *USER DEFINED* EDID option, click the open field to locate the .bin EDID file on your local computer, then click *APPLY*.

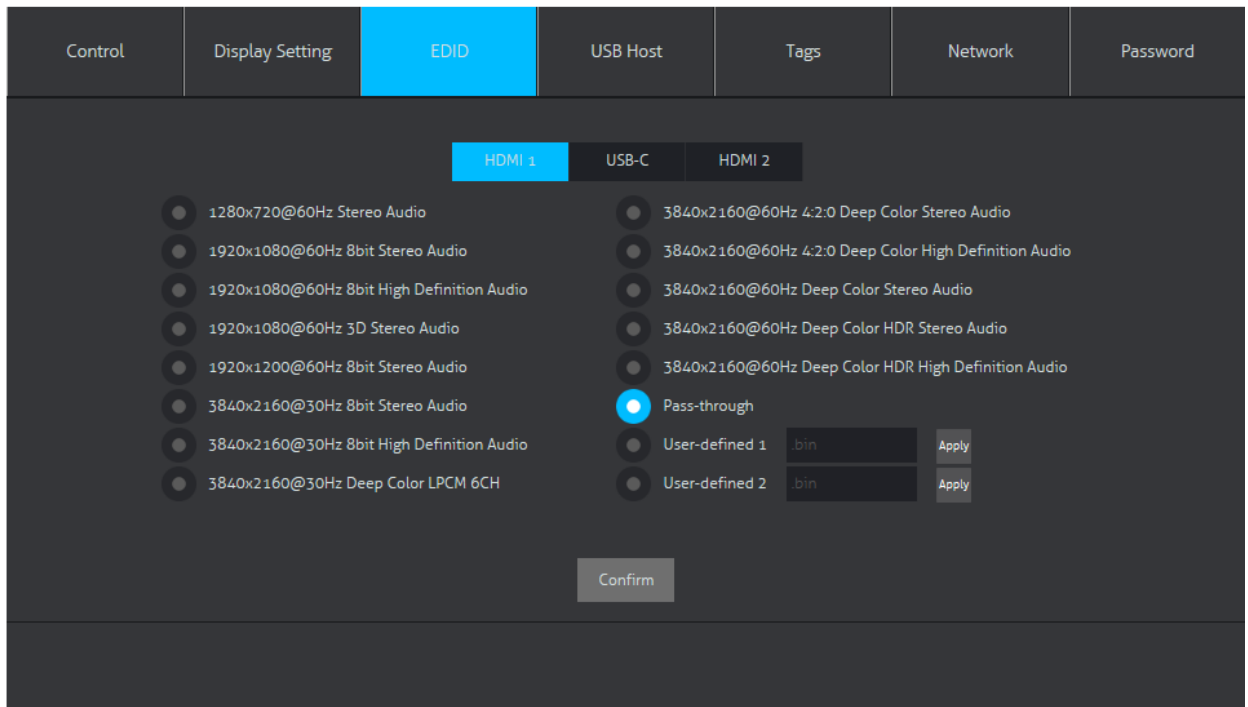

In the event EDID fails the DL-SC31U-BX will default to 1080p for all inputs.

### Renaming Inputs

The *Tags* menu allows you to set user defined names for inputs that will be displayed on the VIDEO tab for easy system control

Navigate to the *Tags* menu, enter in the desired names for the *INPUTS*, then click *CONFIRM*.

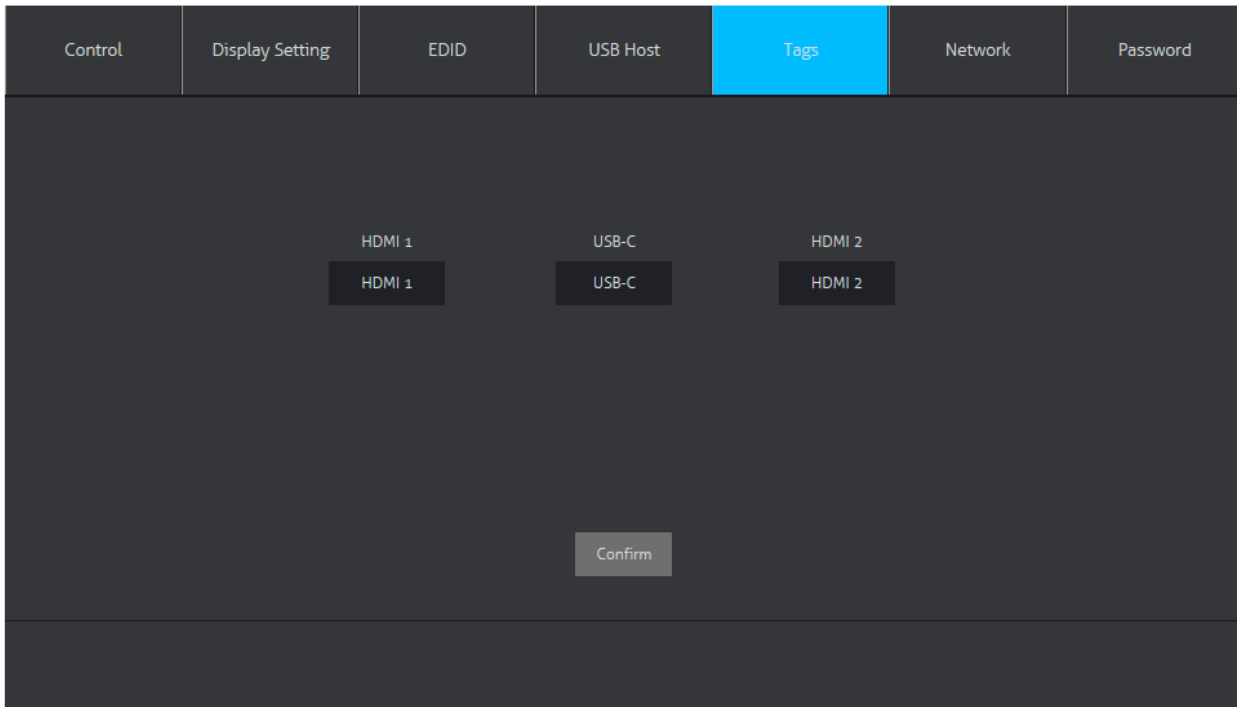

## Network Settings

The *Network* menu allows you to set the network settings for the device.

Navigate to the *Network* menu, select either *DHCP* or *STATIC IP* as the desired IP mode. If choosing *DHCP*, make sure the DL-SC31U-BX is connected to a router / network switch with DHCP server support. When choosing the *STATIC IP* option, manually enter in the desired *IP ADDRESS*, *SUBNET MASK* and *GATEWAY* information, then click *CONFIRM* for changes to take place. Depending on the newly given IP address range you may need to adjust your computers IP address settings to log back into the web GUI server for the DL-SC31U-BX

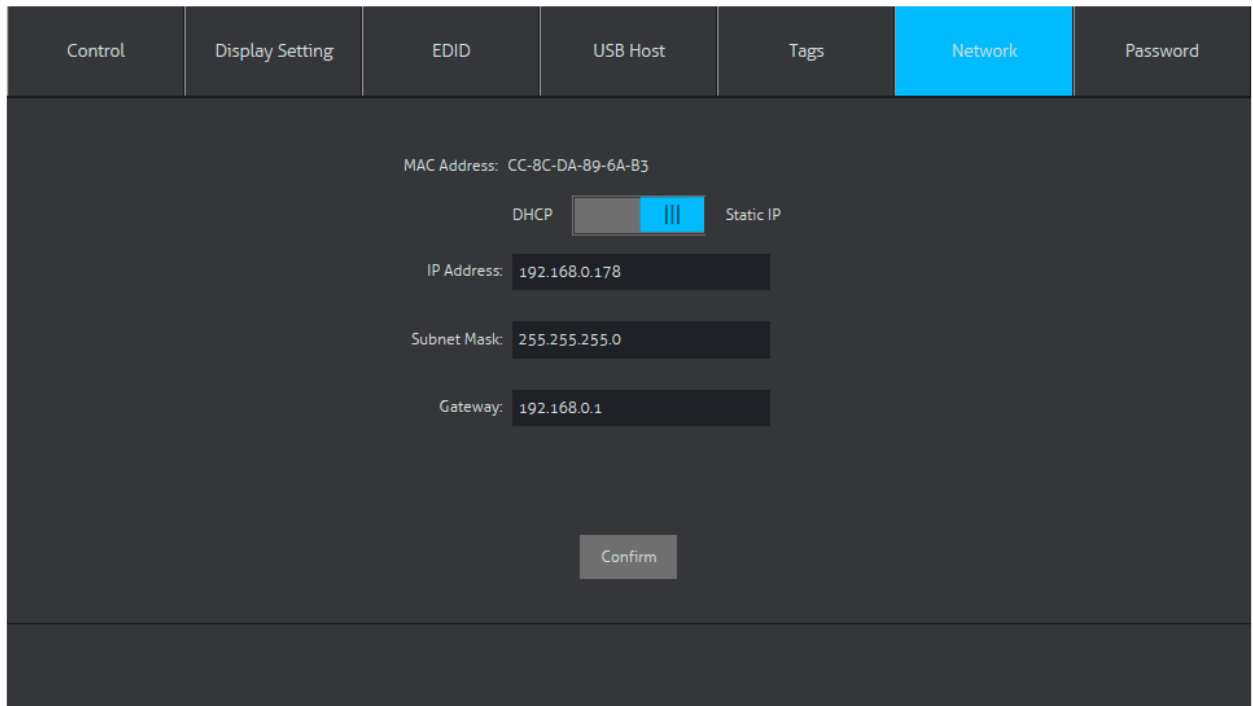

The screenshot displays the Network Settings page of the DL-SC31U-BX web GUI. The interface features a dark theme with a navigation bar at the top containing tabs for Control, Display Setting, EDID, USB Host, Tags, Network (highlighted in blue), and Password. Below the navigation bar, the MAC Address is shown as CC-8C-DA-89-6A-B3. The IP mode is set to Static IP, indicated by a blue bar and three vertical lines. The IP Address field contains 192.168.0.178, the Subnet Mask field contains 255.255.255.0, and the Gateway field contains 192.168.0.1. A Confirm button is located at the bottom center of the form.

### Security Settings

The *PASSWORD* menu allows you to set the admin password to a user defined password

Navigate to the *PASSWORD* menu, enter in a user defined password in the password field, then click *CONFIRM*.

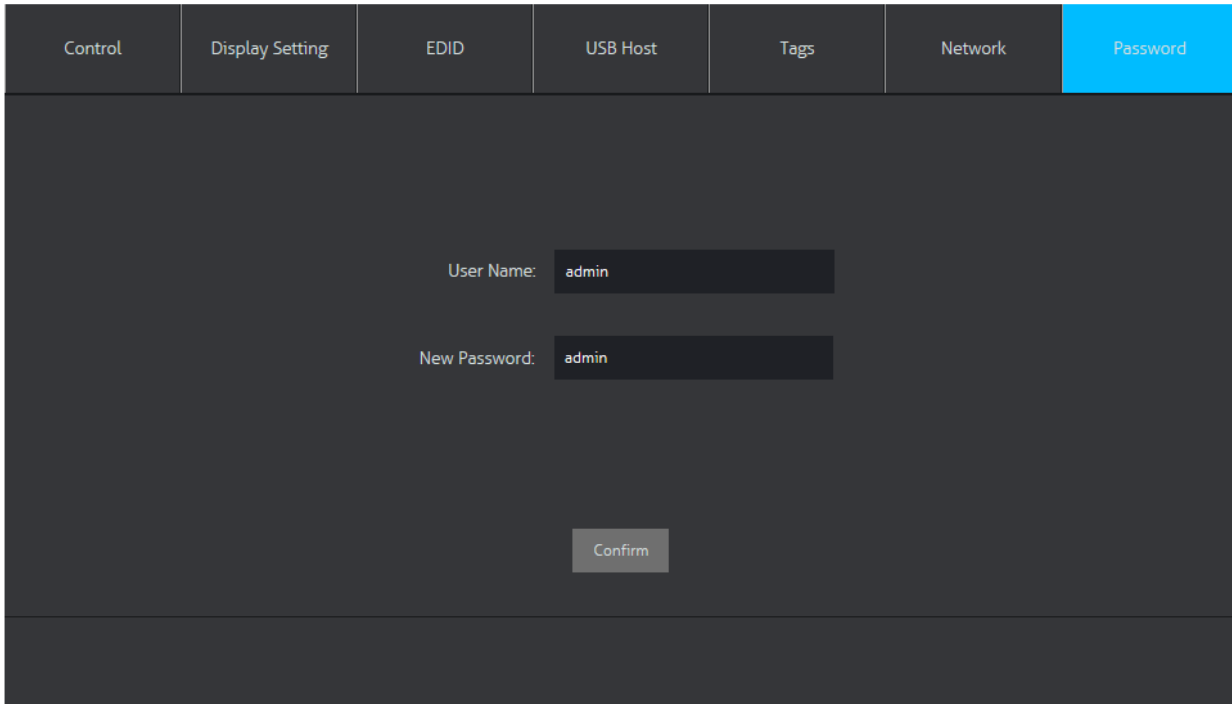

The screenshot shows a web interface with a dark theme. At the top, there is a navigation bar with several menu items: Control, Display Setting, EDID, USB Host, Tags, Network, and Password. The Password menu item is highlighted in blue. Below the navigation bar, the main content area is dark gray. It contains two text input fields. The first field is labeled "User Name:" and contains the text "admin". The second field is labeled "New Password:" and also contains the text "admin". Below these fields is a button labeled "Confirm".

### System Settings

The *CONTROL* menu allows you to change the DL-SC31U-BX switcher to factory default the unit or turn the POWER OFF to the switcher

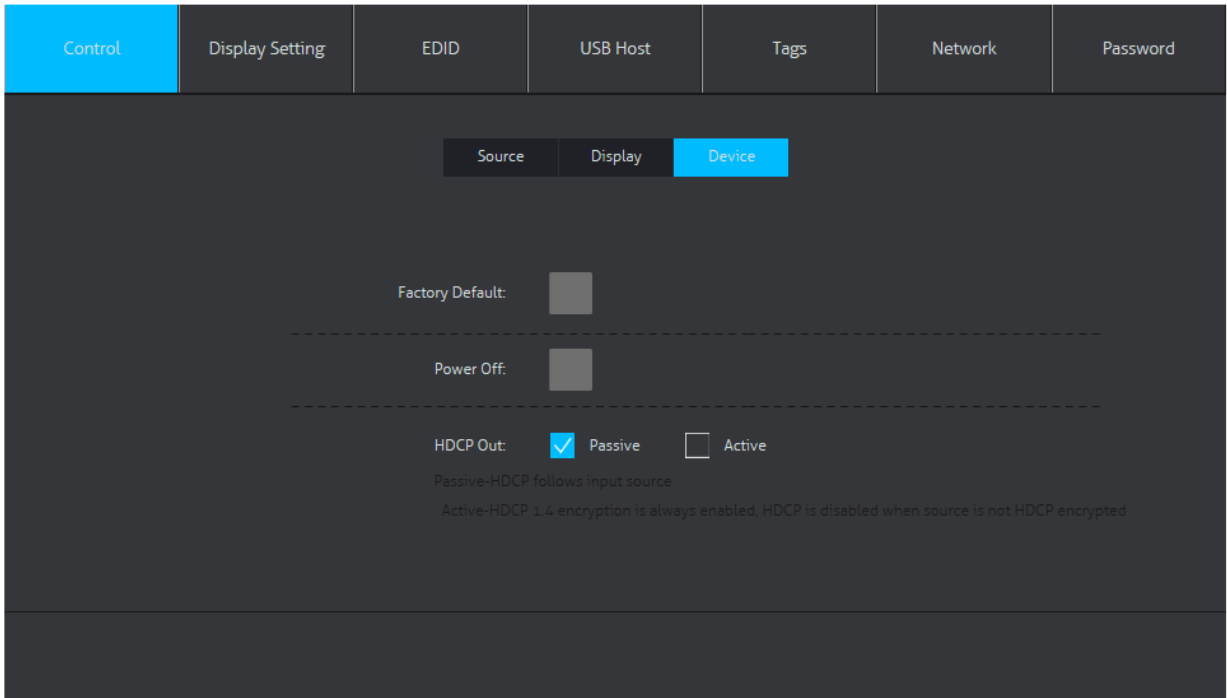

## RS232 and TCP/IP Control

RS232 Settings: 9600 baud, 8 Data bits, 1 Stop bit, Parity = None

Telnet Settings: User defined IP address (default IP address:192.168.0.178), port 4001

The commands are case sensitive and must be terminated with a carriage return <CR> and line feed <LF>

### A/V Routing

Description	Command	Examples
Set output switching mode to manual switching or to auto switching  <b>NOTE:</b> When using the manual switching commands in this API the switching mode status should be set to MANUAL	<pre>#SET_AUTO_SWITCH {M}  {M} = 0 (MANUAL)       1 (AUTO)</pre>	<pre>Command: #SET_AUTO_SWITCH 0  Response: @HDMI_AUTO_SWITCH 0</pre>
Query switching mode status	<pre>#GET_AUTO_SWITCH</pre>	<pre>Command: #GET_AUTO_SWITCH  Response: @HDMI_AUTO_SWITCH 0</pre>
Routing inputs to outputs	<pre>#SET_AV {I}  {I} = H1 (HDMI 1)       H2 (HDMI 2)       C (USB-C)</pre>	<pre>Command: #SET_AV H1  Response: @HDMI_AV H1</pre>
Query routing status	<pre>#GET_AV</pre>	<pre>Command: #GET_AV  Response: @HDMI_AV H1</pre>

## USB Host Routing

Description	Command	Examples
Set USB switching mode to manual switching or to auto switching or to follow video inputs  <b>NOTE:</b> When using the manual switching commands in this API the switching mode status should be set to MANUAL	<pre>#SET_USB_SWITCH_MODE {m}  {m} = 0 (AUTO)       1 (MANUAL)       2 (FOLLOW VIDEO)</pre>	<pre>Command: #SET_USB_SWITCH_MODE 0  Response: @USB_SWITCH_MODE 0</pre>
Query switching mode status	<pre>#GET_USB_SWITCH_MODE</pre>	<pre>Command: #GET_USB_SWITCH_MODE  Response: @USB_SWITCH_MODE 0</pre>
Switching / selecting USB Host	<pre>#SET_USB_MANUAL {H}  {H} = PC1       PC2       USBC</pre>	<pre>Command: #SET_USB_MANUAL PC1  Response: @USB_CH PC1</pre>
Query selected USB Host	<pre>#GET_USB_SWITCH</pre>	<pre>Command: #GET_USB_SWITCH  Response: @USB_CH PC1</pre>

## CEC / RS232 Display Control

Description	Command	Examples
<p>Send TV ON/OFF display commands using CEC (HDMI) or RS232</p> <p><b>NOTE:</b> The RS232 commands can be configured and stored in the web GUI, see page 14</p>	<pre>#SET_DISPLAY {S}  {S} = ON, OFF</pre>	<p>Command:</p> <pre>#SET_DISPLAY ON</pre> <p>Response:</p> <pre>@SET_HDMI_ ON</pre>



## System Commands

Description	Command	Examples
Set switcher in standby mode	<pre>#SET_POWER {M}  {M} = 0 (STANDBY)       1 (ON)</pre>	<pre>Command: #SET_POWER 0  Response: @POWER 0</pre>
Query standby status	<pre>#GET_POWER</pre>	<pre>Command: #GET_RELAY_AUTO_TIME  Response: @POWER 0</pre>
Set baud rate of switcher	<pre>#SET_RS232_BAUD {B}  {B} = 0 (115200)       1 (57600)       2 (38400)       3 (19200)       4 (9600)       5 (4800)       6 (2400)</pre>	<pre>Command: #SET_RS232_BAUD 4  Response: @RS232_BAUD 4</pre>
Query current baud rate	<pre>#GET_RS232_BAUD</pre>	<pre>Command: #GET_RS232_BAUD  Response: @RS232_BAUD 4</pre>
Front panel button lock	<pre>#SET_KEYPAD_LOCK {K}  {K} = 0 (UNLOCK)       1 (LOCK)</pre>	<pre>Command: #SET_KEYPAD_LOCK 0  Response: @KEYPAD_LOCK 0</pre>
Query button lock status	<pre>#GET_KEYPAD_LOCK</pre>	<pre>Command: #GET_KEYPAD_LOCK  Response: @KEYPAD_LOCK 0</pre>
Reboot	<pre>#REBOOT</pre>	<pre>Command: #REBOOT  Response: @REBOOT</pre>
Factory Reset	<pre>#FACTORY_RESET</pre>	<pre>Command: #FACTORY_RESET  Response: @FACTORY RESET</pre>

# Technical Specifications

<b>Video</b>	
Video Inputs	(2) HDMI, (1) USB-C
Video Input Connector	(2) HDMI type A, (1) USB TYPE C
Input Video Signal	HDMI for HDMI input, Display Port Alternate Mode for USB-C
Video Output	(1) HDMI
Video Output Connector	(1) HDMI type A
Input Resolution Support	HDMI: Up to 3840 x 2160 @60Hz / 4:4:4 / 8 bit deep color USB-C: Up to 3840 x 2160 @30Hz / 4:4:4 / 8 bit deep color
Output Resolution Support	HDMI: Up to 4K@60Hz 4:4:4
Standards	Compliant with HDMI 2.0b, HDCP 2.2 and CEC
Bandwidth	All Inputs: 18Gbps HDMI Output: 18Gbps
<b>USB</b>	
Supported USB Standard	Local Switcher: Up to USB 3.2 Gen 1 @ 5Gbps
USB Port Types	(2) USB B (Host) (1) USB C (Host) (4) USB A (Client, two on top, two on bottom)
<b>Audio</b>	
Supported output formats	HDMI Embedded: LPCM 7.1 audio, Dolby Atmos®, Dolby® TrueHD, Dolby Digital® Plus, DTS: X™, and DTS-HD® Master Audio™ pass-through
<b>Device Control Parameters</b>	
Ethernet	100BaseT
RS232 Baud Rate	9600 baud (default)
<b>Chassis and Environmental</b>	
Dimensions (WxHxD)	155 mm x 200 mm x 128 mm (8.7 in x 1.7 in x 5.1 in)
Shipping Weight	1.92kg (1.3lbs.)
Operating Temperature	0° to +55° C (+32° to +131° F)
Operating Humidity	10% to 90%, Non-condensing
Storage Temperature	-20° to +70° C (+14° to +158° F)
Storage Humidity	10% to 90%, Non-condensing
<b>Power, ESD, and Regulatory</b>	
Power Supply Input	100V-240VAC / 50-60 Hz
Power Supply Output	24VDC / 5A
Power Consumption	60 watts
USB-C Power Consumption	40 watts
ESD Protection	15kV
Product Regulatory	FCC, CE, RoHS
Power Supply Regulatory	CE, RoHS
<b>Other</b>	
Standard Warranty	5 years
Included Accessories	Cut out guide, Power Supply with US, UK, AU and EU power plugs, (1) 3-pin to DB9 RS232 Cable, (2) Mounting clips with screws (1) Lacing Bar

# Device Dimensions

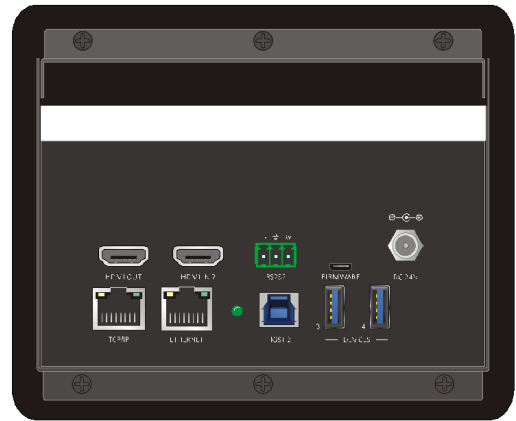
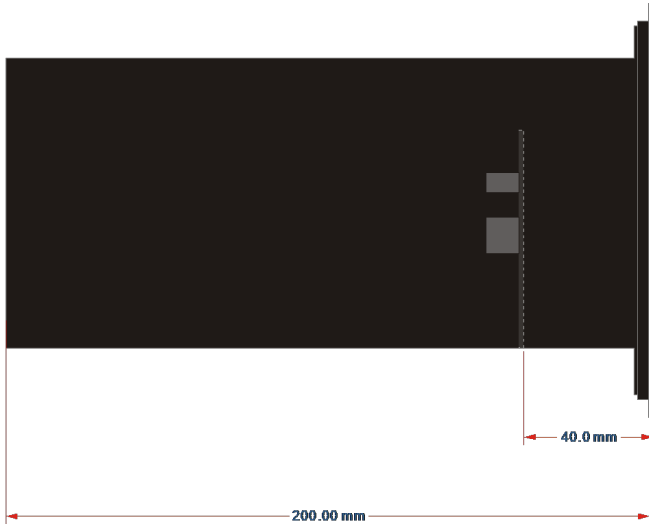
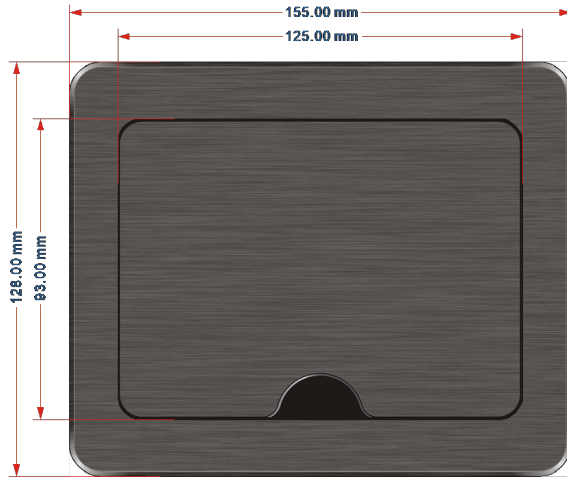

Thank you for your purchase.

For Technical Support please call our toll  
free number at 800-530-8998 or email us at  
[supportlibav@libav.com](mailto:supportlibav@libav.com)

[www.libav.com](http://www.libav.com)

Digitalinx is a brand of:

