

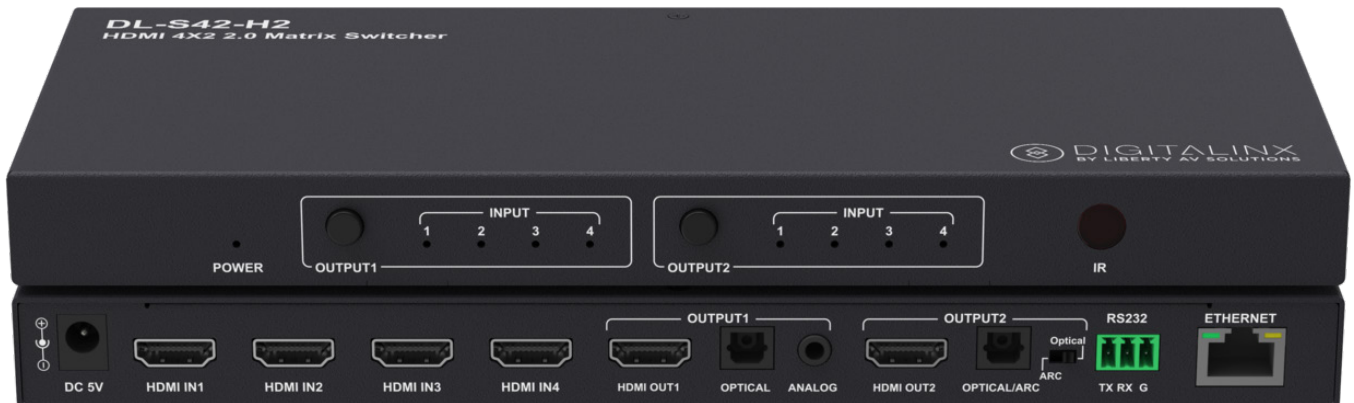

DIGITALINX
VALUE-ENGINEERED DIGITAL SOLUTIONS

DL-S42-H2 Owners Manual



Important Safety Instructions

- » Please completely read and verify you understand all instructions in this manual before operating this equipment.
- » Keep these instructions in a safe, accessible place for future reference.
- » Heed all warnings.
- » Follow all instructions.
- » Do not use this apparatus near water.
- » Clean only with a dry cloth.
- » Do not install near any heat sources such as radiators, heat registers, stoves, or other apparatus (including amplifiers) that produce heat.
- » Use only accessories specified or recommended by Intelix.
- » Explanation of graphical symbols:

◊ Lightning bolt/flash symbol: the lightning bolt/flash and arrowhead within an equilateral triangle symbol is intended to alert the user to the presence of uninsulated “dangerous voltage” within the product enclosure which may be of sufficient magnitude to constitute a risk of shock to a person or persons.



◊ Exclamation point symbol: the exclamation point within an equilateral triangle symbol is intended to alert the user to the presence of important operating and maintenance (servicing) instructions in the literature accompanying the product.



- » **WARNING: TO REDUCE THE RISK OF FIRE OR ELECTRIC SHOCK, DO NOT EXPOSE THIS APPARATUS TO RAIN OR MOISTURE AND OBJECTS FILLED WITH LIQUIDS, SUCH AS VASES, SHOULD NOT BE PLACED ON THIS APPARATUS.**
- » Use the mains plug to disconnect the apparatus from the mains.
- » **THE MAINS PLUG OF THE POWER CORD MUST REMAIN READILY ACCESSIBLE.**
- » Do not defeat the safety purpose polarized or grounding-type plug. A polarized plug has two blades with one wider than the other. A grounding-type plug has two blades and a third grounding prong. The wide blade or the third prong is provided for your safety. If the provided plug does not fit into your outlet, consult an electrician for replacement of your obsolete outlet. **Caution! To reduce the risk of electrical shock, grounding of the center pin of this plug must be maintained.**
- » Protect the power cord from being walked on or pinched particularly at the plugs, convenience receptacles, and the point where they exit from the apparatus.
- » Do not block the air ventilation openings. Only mount the equipment per Intelix’s instructions.
- » Use only with the cart, stand, table, or rack specified by Intelix or sold with the equipment. When/if a cart is used, use caution when moving the cart/equipment combination to avoid injury from tip-over.
- » Unplug this apparatus during lightning storms or when unused for long periods of time.
- » **Caution! Shock Hazard.** Do not open the unit.
- » Refer to qualified service personnel. Servicing is required when the apparatus has been damaged in any way, such as power supply cord or plug is damaged, liquid has been spilled or objects have fallen into the apparatus, the apparatus has been exposed to rain or moisture, does not operate normally, or has been dropped.



Table of Contents

Product Overview	4
Product Contents	4
Front and Rear Panels	5
<i>Front / Back Panel</i>	5
Installation Instructions	6
<i>Mount the Matrix</i>	6
<i>Mounting Instructions</i>	6
<i>Connect Sources</i>	6
<i>Connect Displays</i>	6
<i>Connect Audio (Optional)</i>	7
<i>Connect RS232 Control (Optional)</i>	7
<i>Connect Ethernet (Web Browser) Control (Optional)</i>	8
<i>Applying Power</i>	8
A/V Diagram	9
Web Browser Control / System Settings	10
<i>Logging In</i>	10
<i>Audio / Video Switching</i>	11
<i>Audio Mute</i>	11
<i>Display Control</i>	12
<i>EDID Settings for Inputs</i>	13
<i>Network Settings</i>	14
<i>Change Password</i>	15
IR Remote Control	16
RS232 and TCP/IP Control Configuration	17
<i>Video Switching</i>	17
<i>Audio Mute</i>	17
<i>CEC Setup and Control</i>	18
<i>EDID Configuration</i>	19
<i>System Settings / Factory Default</i>	20
Technical Specifications	21

Product Overview

The DigitaLinx DL-S42-H2 is a simple 4x2 HDMI 2.0 matrix switcher that features four HDMI inputs and two HDMI outputs with HDCP 2.2 support and capable of handling resolutions up to 4K@60Hz 4:4:4 / 8 bit color with static and dynamic HDR output support. The DL-S42-H2 supports digital optical audio de-embedding from both outputs and analog audio de-embedding from output 1. The switcher also supports Audio Return Channel (ARC) on output 2, the digital optical audio on output 2 can be configured manually to either pass the HDMI audio stream from the routed HDMI input or from the HDMI / ARC audio stream from the connected TV. Each output port supports auto down scaling from 4K to 1080P independently.

The DL-S42-H2 can be controlled via front panel buttons, IR remote, API commands using RS232 or Ethernet. A web server / GUI is built in that features A/V switching control, automatic display control and input EDID management.

Product Contents

- DL-S42-H2 HDBaseT Receiver
- (1) Quick Install Guide
- (1) IR Remote
- (1) 3 pin Phoenix Male Connector
- (1) DC5V Power Supply with US, UK, EU and AU adapter plugs
- (2) Mounting Brackets

Front and Rear Panels

Front / Back Panel

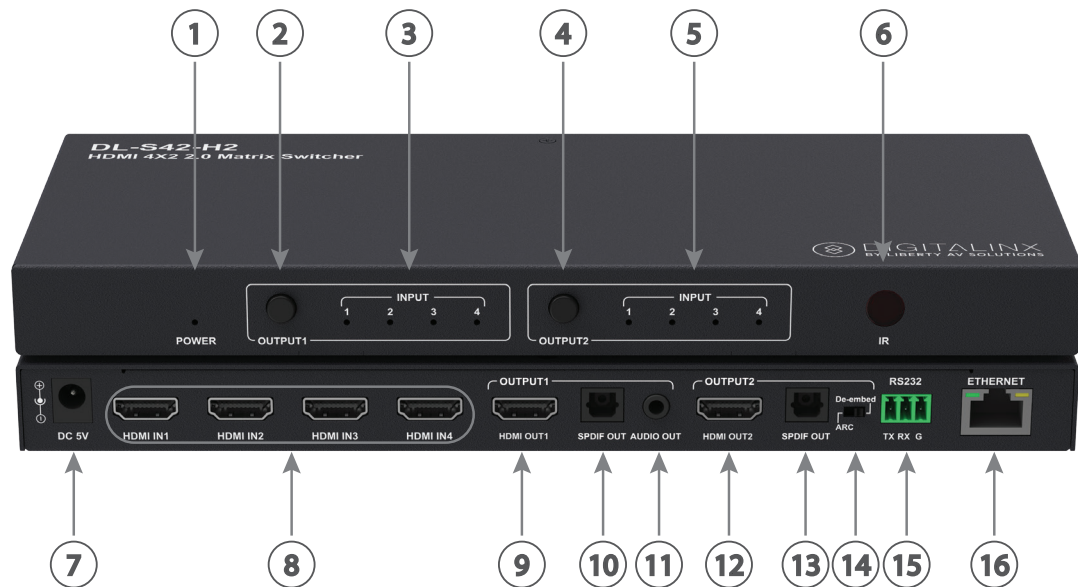

1. POWER LED
 - When ON; Device is powered on
 - When OFF; Device is powered off
2. OUTPUT1 - Output 1 input selection button
3. INPUT LEDs
 - When ON; HDMI (1-4) is selected
 - When OFF; HDMI (1-4) is not selected
4. OUTPUT2 - Output 2 input selection button
5. INPUT LEDs
 - When ON; HDMI (1-4) is selected
 - When OFF; HDMI (1-4) is not selected
6. IR - IR Receiver window
7. DC5V - Power plug input
8. HDMI IN 1-4- HDMI Inputs 1-4
9. HDMI OUT1- HDMI Output 1
10. OPTICAL- Digital audio output - de-embeds multi channel HDMI audio from selected input
11. ANALOG- Analog audio output - de-embeds 2 channel HDMI audio from selected input
12. HDMI OUT2- HDMI Output 2
13. OPTICAL / ARC- Digital audio output - de-embeds multi channel HDMI audio from selected input OR via ARC / HDMI from connected TV display
14. OPTICAL / ARC SWITCH- Manual switch for configuring digital audio output
15. RS232- Phoenix connector for RS232 system control
16. Ethernet- RJ45 connector for Ethernet system control

Installation Instructions

Mount the Matrix

At least 2 inches of free air space is required on both sides of the DL-S42-H2 for proper side ventilation. Avoid mounting the DL-S42-H2 near a power amplifier or any other source of significant heat.

Mounting Instructions

Remove the four screws on both sides of the DL-S42-H2, then attach the supplied mounting clips to the DL-S42-H2 for surface or rack mounting.

Connect Sources

Connect source devices to the HDMI inputs. When using HDMI cables for source inputs, use a High Speed HDMI cable that is less than or equal to 5 meters in length for 4k60 signals and 8 meters for 1080p signals. For source devices that are further away, it is highly recommended to install an HDMI extender such as the Digitalinx DL-HD70, DL-HDE100, DL-HDE100-H2 or the DL-HD2100.

Connect Displays

Connect the display device to the HDMI output using a High Speed HDMI cable that is less than or equal to 5 meters in length for 4k60 signals and 8 meters for 1080p signals. For display device that is further away, it is highly recommended to install an HDMI extender such as the Digitalinx DL-HD70, DL-HDE100, DL-HDE100-H2 or the DL-HD2100.

Connect Audio (Optional)

Connect an audio amplifier to the audio output of the DL-S42-H2, the switcher features a 3.5mm analog audio output on output 1 and digital output on output 1 and output 2.

NOTE: On output 2, you can choose to de-embed the audio either from a routed input or via ARC from a connected smart TV. Flip the output 2 audio switch from *DE-EMBED* to *ARC* as needed

Connect RS232 Control (Optional)

Connect a control system to the DL-S42-H2 via RS232 for switcher control.

RS232 Wiring

Connect the system controller RX signal to TX on the DL-S42-H2, then connect the controllers TX signal to RX on the DL-S42-H2.

RS232 Settings:

- 115200 baud
- 8 Data Bits
- 1 Stop Bit
- Parity = none

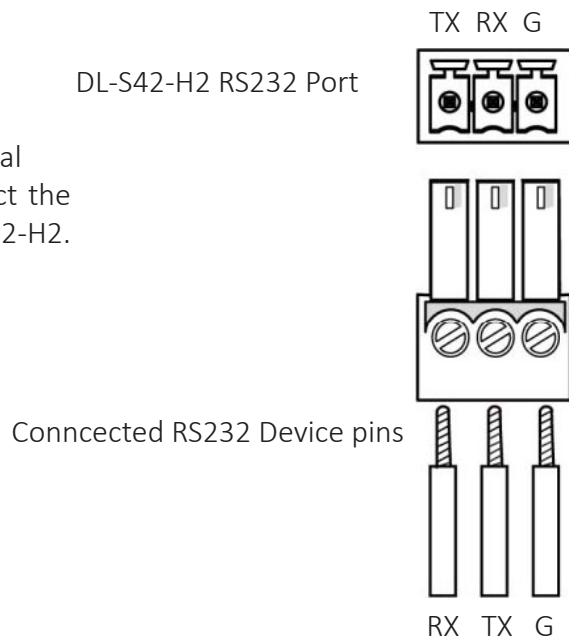

Connect Ethernet (Web Browser) Control (Optional)

The DL-S42-H2 may be controlled via Ethernet through a web browser interface.

The TCP/IP port requires a standard straight-through Category 5 or greater cable with the TIA/EIA-568B crimp pattern for optimal operation.

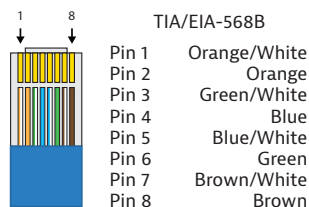

The default settings for the TCP/IP port are:
IP address: 192.168.1.254, Telnet Port 23

Connect the Ethernet cable between to the matrix and a router with a straight-through cable or between the matrix and a computer with a crossover cable.

Applying Power

Connect the included power supply to the DL-S42-H2

A/V Diagram

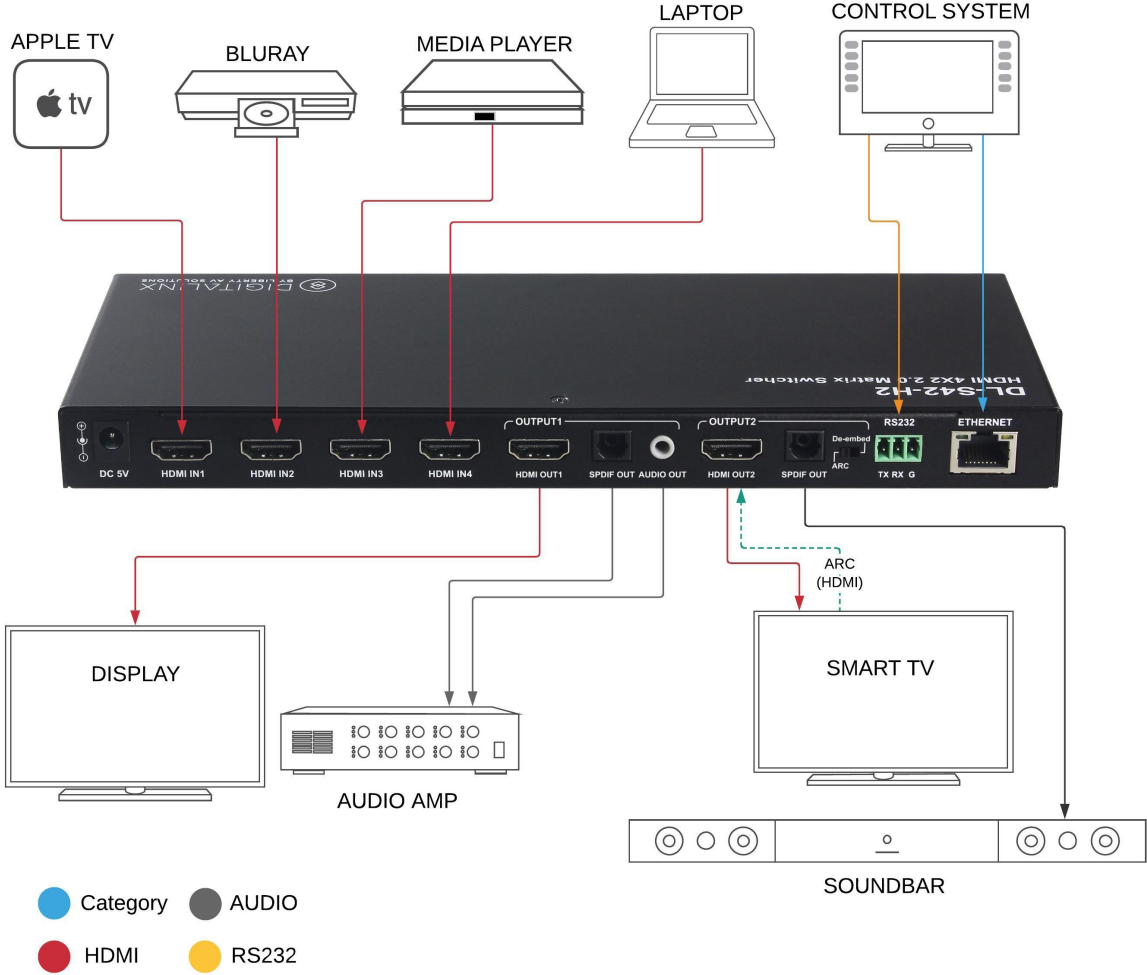

Web Browser Control / System Settings

Logging In

Open a web browser and type in IP address of the DL-S42-H2. The default IP address is 192.168.1.254. Be sure the computer you are using to connect to the DL-S42-H2 is in the same IP range.

The login screen will appear. The default user name and password is *admin*



Audio / Video Switching

The VIDEO menu allows you to route inputs to the outputs of the matrix switcher.

To switch the video route, check the HDMI IN1-IN4 buttons corresponding to the desired output.

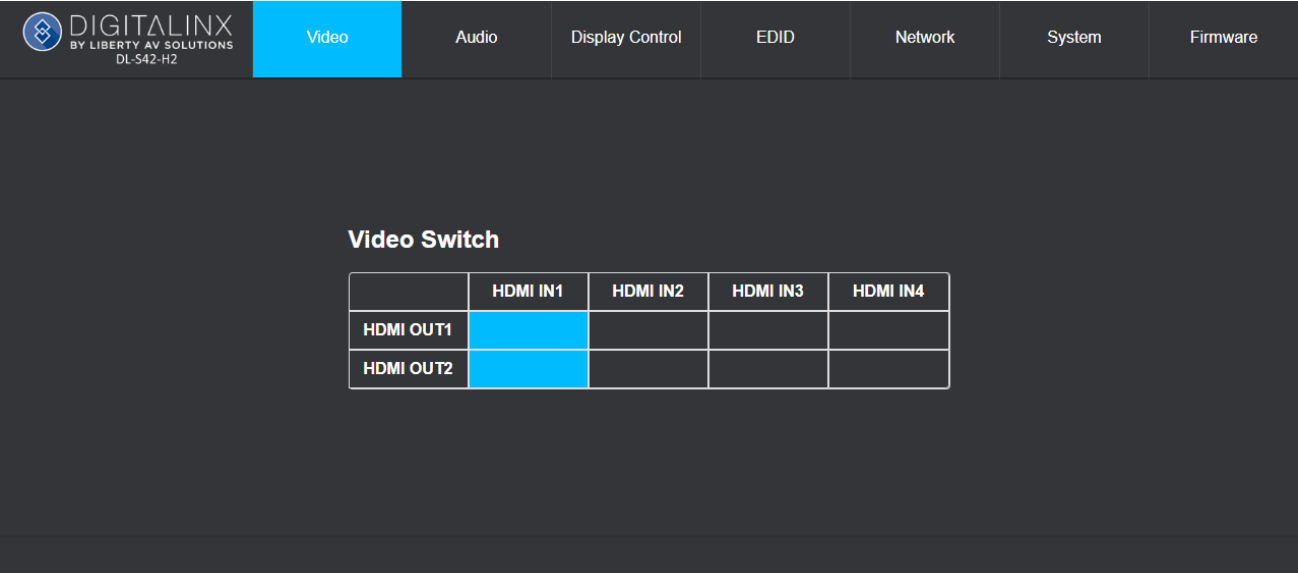

Audio Mute

The AUDIO menu allows you to mute/un-mute various audio outputs.

To mute a video output, select the ON button for that output. To un-mute, select the OFF button. By default all audio outputs are un-muted.

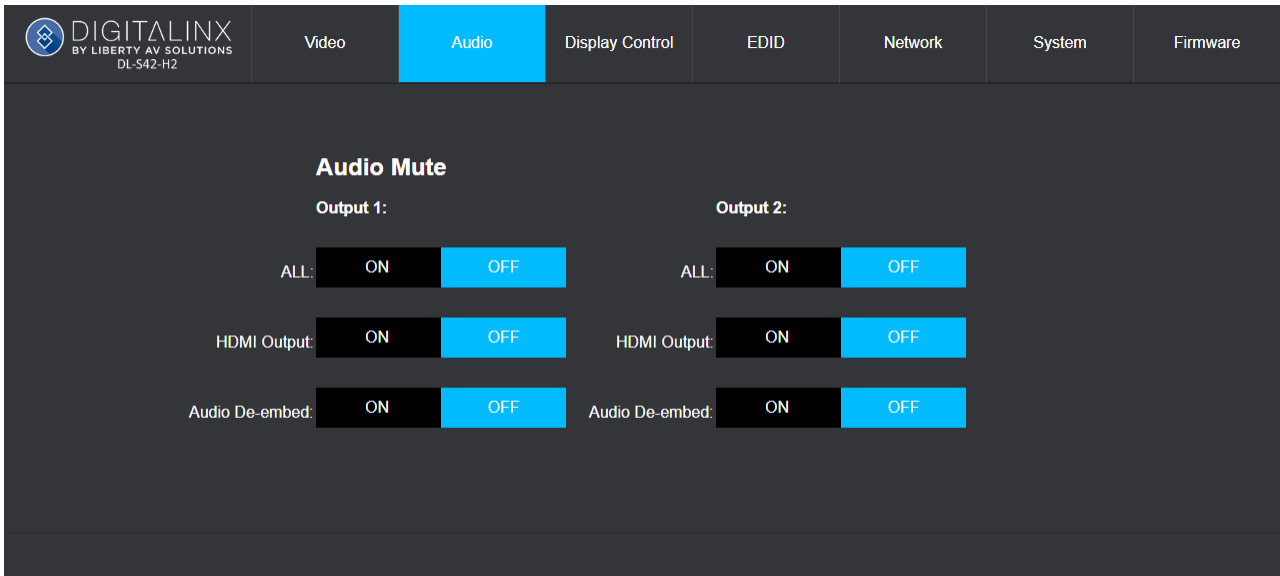

Display Control

The *Display Control* menu allows you to control the connected display via CEC/HDMI as well as automate the display on or off based on presence of signal.

To control the display connected to an output using CEC via the connected HDMI cable, make sure that a CEC compatible TV display is used. CEC settings for displays must also be turned ON, consult the TV displays owners manual on how to engage or turn ON CEC control.

To turn a TV on or off via CEC/HDMI click the *ON* or *OFF* button on the desired output under the *MANUAL* section.

To configure a display to turn automatically on or off via CEC/HDMI whenever a signal is or is not present to the existing input route, click the *ON* button under *OUTPUT 1* or *OUTPUT 2* in the *AUTOMATIC* section. Then configure the *DELAY TIME* to turn OFF the display via CEC whenever there is no signal connected to the existing route, you can choose up to 30 minutes for the display to automate OFF if there is no signal present to the route.

NOTE: In order to trigger the CEC ON status whenever a display is in an OFF status, a signal must be connected to the existing route.

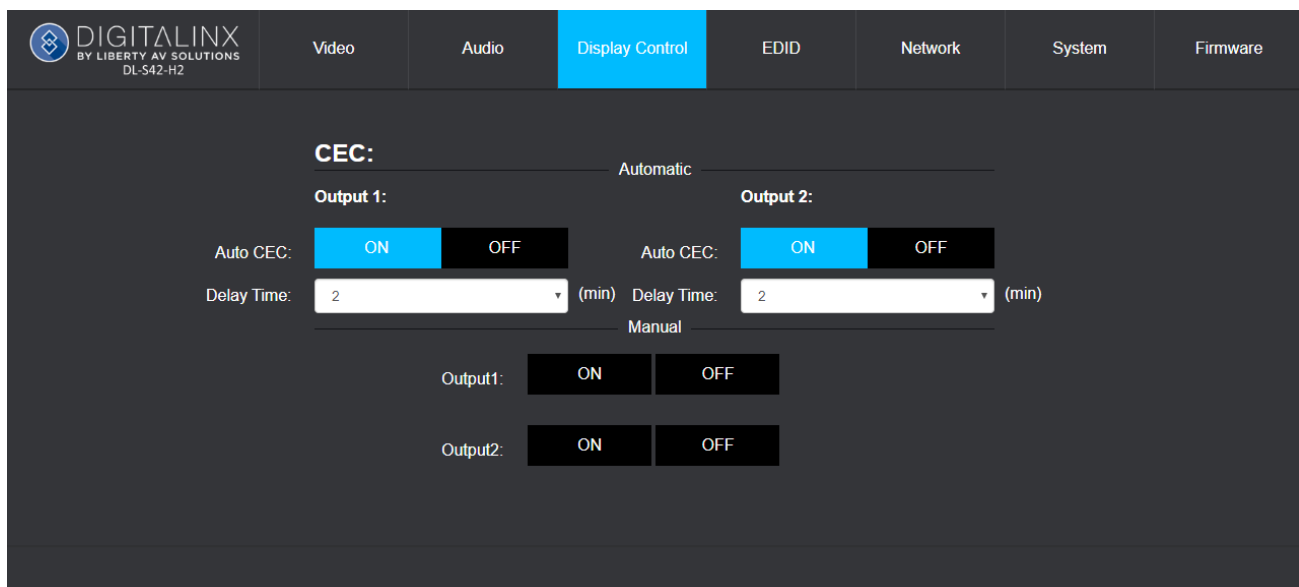

EDID Settings for Inputs

The *EDID* menu allows you to select a desired EDID table to used for source compatibility communication.

To select a pre-defined EDID setting, choose the desired EDID in the drop down menu for each input and then click *Confirm*.

If EDID fails, the switcher will default to 3460 x x2160 @ 60 Hz.

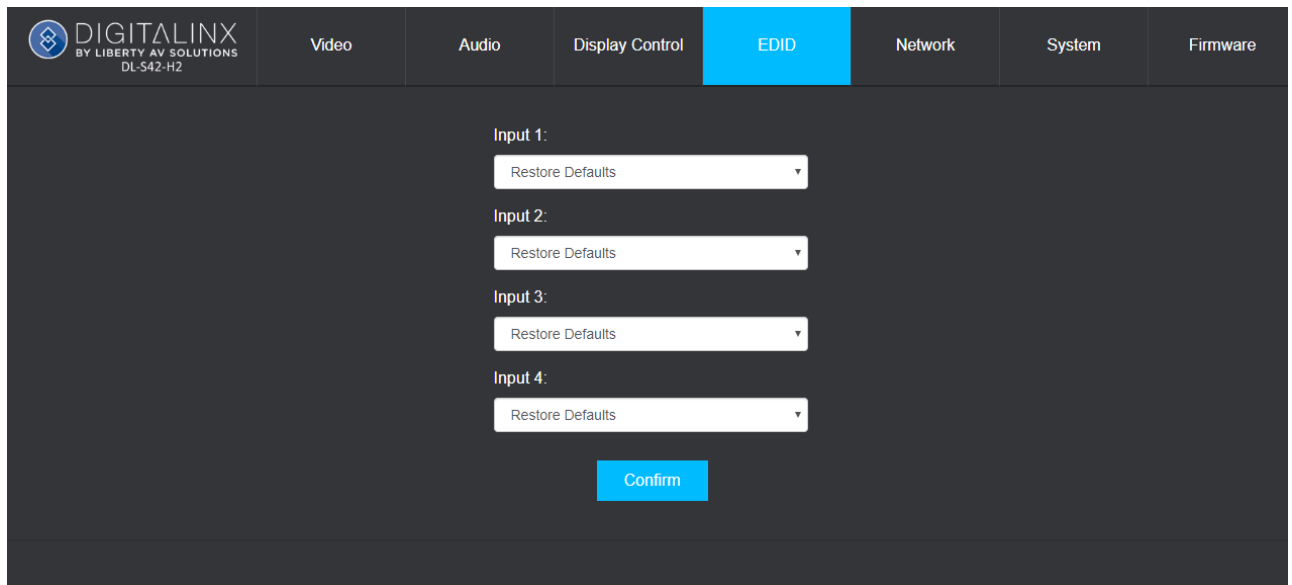

The screenshot shows the web interface for the DL-S42-H2 switcher. The top navigation bar includes the Digitalinx logo and several menu items: Video, Audio, Display Control, EDID (highlighted in blue), Network, System, and Firmware. The main content area is dark grey and contains four input settings, each with a dropdown menu set to 'Restore Defaults':

- Input 1: Restore Defaults
- Input 2: Restore Defaults
- Input 3: Restore Defaults
- Input 4: Restore Defaults

At the bottom of the settings area is a blue 'Confirm' button.

Network Settings

The *Network* menu allows you to set the IP address mode to either Static or DHCP, by default the DL-S42-H2 is set to Static mode with a pre-defined IP address of 192.168.1.254 / subnet 255.255.255.0 and gateway set to 192.168.1.1

Check either the *DHCP* or *Static* mode to change IP modes. If using a Static IP address enter in the IP address, subnet and gateway. Then click *Confirm*. You will need to reboot the switch for the new network settings to take place.

DIGITALINX
BY LIBERTY AV SOLUTIONS
DL-S42-H2

Video Audio Display Control EDID **Network** System Firmware

MAC Address: 34:1B:22:80:D6:BA

Mode: DHCP Static IP

IP Address: 192.168.1.254

Subnet Mask: 255.255.255.0

Gateway: 192.168.1.1

Confirm

Change Password

The *System* menu allows you to change the password credentials for the admin login

To change the password for the admin login, enter in the desired password then click *Confirm*

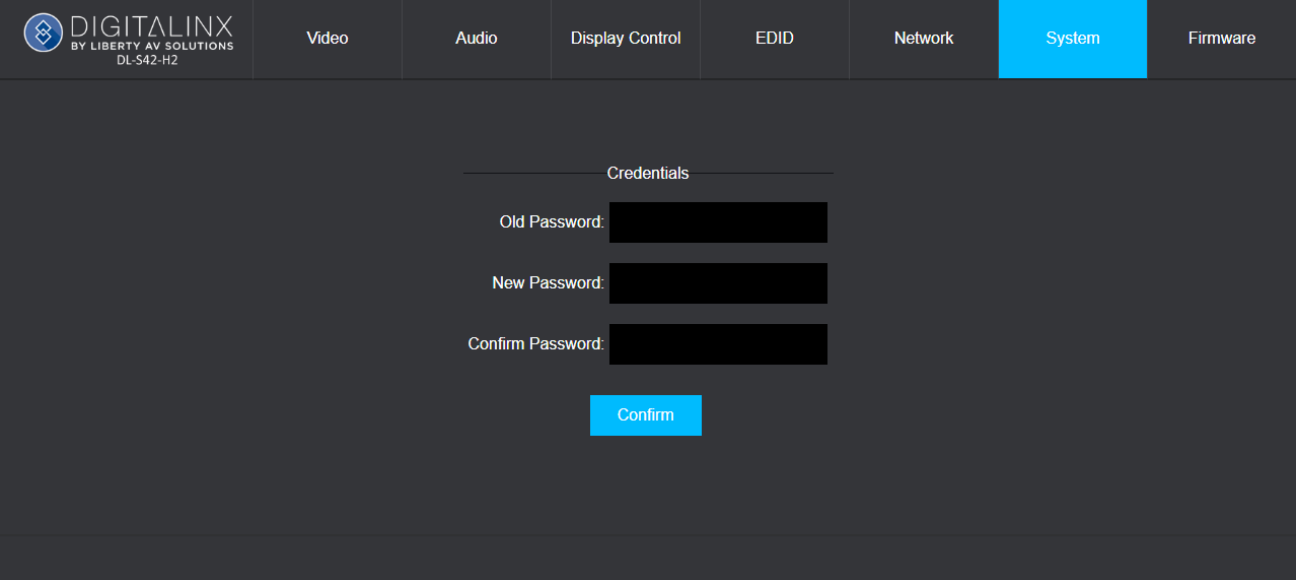

IR Remote Control

The DL-S42-H2 includes a IR remote which performs routing functions available on the front panel of the switcher and allow the ability to turn the display on/off using CEC

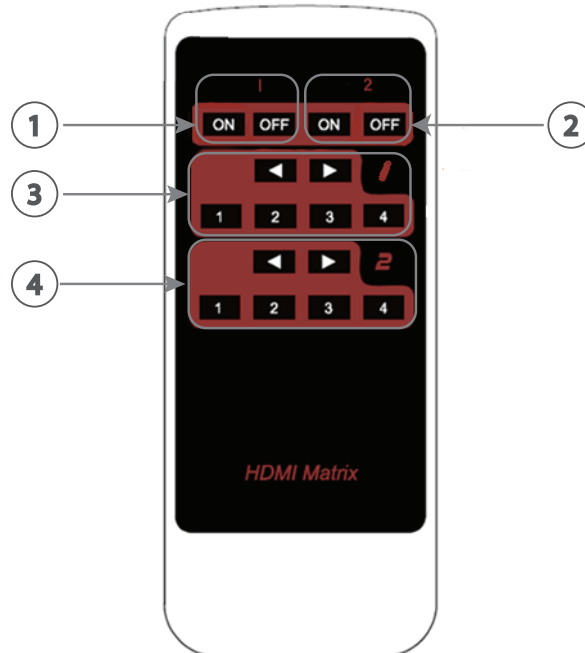

1. Turns display connected to output 1 on/off using CEC/HDMI
2. Turns display connected to output 2 on/off using CEC/HDMI
3. Input selection buttons for output 1
4. Input selection buttons for output 1

RS232 and TCP/IP Control Configuration

RS232 Settings: 115200 baud, 8 Data bits, 1 Stop bit, Parity = None

Telnet Settings: User defined IP address (default IP address:192.168.1.254), port 23

There are no spaces between any of the characters in the command string. The commands are case sensitive

All responses end in a carriage return (hex 0D) and a line feed (hex 0A).

<CR> = Carriage return (Hex 0D)

<LF> = Line Feed (Hex 0A)

Video Switching

Source switching for the DL-S42-H2 can be performed manually with the command strings below.

Description	Command	Example
Switch input 1-4 to output 1-2	SET SW {i} {o} {i} = [in1, in2, in3, in4] {o} = [out1, out2]	Command: SET SW in1 out1<CR><LF> Return: SW in1 out2<CR><LF>
Switch input to all outputs	SET SW {i} all {i} = [in1, in2, in3, in4]	Command: SET SW in1 all<CR><LF> Return: SW in1 all<CR><LF>
Query the output routing status	GET MP {o} {o} = [out1, out2, all]	Command: GET MP out1<CR><LF> Return: MP in1 out1<LF>

Audio Mute

Mute status for the DL-S42-H2 can be performed manually with the command strings below.

Description	Command	Example
Set audio output mute status	SET MUTE {o} {x} {o} = [hdmiaudioout1, hdmiaudioout2, spdifaudioout1, spdifaudioout2, audioout1, audiout2] {x} = [on, off]	Command: SET MUTE audio out1 on<CR><LF> Return: MUTE audioout1 on<CR><LF>
Switch input to all outputs	GET MUTE {o} {o} = [hdmiaudioout1, hdmiaudioout2, spdifaudioout1, spdifaudioout2, audioout1, audiout2, all]	Command: GET MUTE audioout1<CR><LF> Return: MUTE audioutput1 on<CR><LF>
Query the output routing status	GET MP {o} {o} = [out1, out2, all]	Command: GET MP out1<CR><LF> Return: MP in1 out1<LF>

CEC Setup and Control

A CEC enabled displays ON and OFF status can be controlled by the DL-S42-42 via HDMI. By default the CEC control option is always on, simply turn the CEC option ON in the display menu settings to use this control capability.

The TV's CEC ON status can also be automatically generated to a connected display via HDMI when an active video source is connected to the currently routed input. When using auto CEC on / off control of a display, use the CEC power delay commands to define the time when the display will be turned OFF when no video signal is present to the currently routed input. For example if the delay time is set to 3 minutes, the CEC enabled display will turn off when there is no present video signal for 3 minutes. By default the auto CEC control is on and the default delay time is set to 2 minutes.

Use the commands below to adjust the auto CEC settings for CEC control or to turn the connected TV display on/off using CEC.

Description	Command	Example
Set Auto CEC Power On/Off	SET AUTOCEC_FN {o} {x} {o} = [out1, out2] {x} = [on, off]	Command: SET AUTOCEC_FN out1 on<CR><LF> Return: AUTOCEC_FN out1 on<CR><LF>
Query Auto CEC Mode Status	GET AUTOCEC_FN {o} {o} = [out1, out2]	Command: GET AUTOCEC_FN out1<CR><LF> Return: AUTOCEC_FN out1 on<CR><LF>
Set CEC Power OFF Delay Time	SET AUTOCEC_D {o} {t} {o} = [out1, out2] {t} = [1-60] Note: Maximum delay time is 30 minutes	Command: SET AUTOCEC_D 5<CR><LF> Return: AUTOCEC_D 5<CR><LF>
Query CEC Power OFF Delay Time	GET AUTOCEC_D {o} {o} = [out1, out2]	Command: GET AUTOCEC_D out1<CR><LF> Return: AUTOCEC_D out1 5<CR><LF>
Turn display ON/OFF via HDMI/CEC	SET CEC_PWR {o} {x} {o} = [out1, out2] {x} = [on, off]	Command: SET CEC_PWR out1 on<CR><LF> Return: CEC_PWR out1 on<CR><LF>

EDID Configuration

EDID can be configured for each input using the commands below. By default EDID for an input is copied to the routed output, if an input is routed to both outputs it will copy from output 1. If EDID fails the default EDID will set to 3840x2160.

Description	Command	Example
Set Input EDID	<pre>SET EDID {i} {r}</pre> <p><i>{i}</i> = [in, in2, in3, in4]</p> <p><i>{r}</i> = [1-11]</p> <p>1 = Default (Copy from route / output) 2 = Copy from Output1 3 = Copy from Output2 4 = 4K@60Hz 4:4:4, 2.0ch with HDR 5 = 4K@60Hz 4:4:4, 5.1ch, with HDR 6 = 4K@60Hz 4:4:4, 7.1ch, with HDR 7 = 4K@30Hz 4:2:0, 2.0ch, with HDR 8 = 4K@30Hz 4:2:0, 7.1ch, with HDR 9 = 1080P@60Hz, 2.0ch 10 = 1080P@60Hz, 5.1ch 11 = 1080P@60Hz, 7.1ch </p>	<p><i>Command:</i></p> <pre>SET EDID in1 1<CR><LF></pre> <p><i>Return:</i></p> <pre>EDID SET in1 1<CR><LF></pre>
Query Input EDID	<pre>GET EDID {i}</pre> <p><i>{i}</i> = [in1, in2, in3, in4, all]</p>	<p><i>Command:</i></p> <pre>GET EDID in1<CR><LF></pre> <p><i>Return:</i></p> <pre>EDID GET in1 1<CR><LF></pre>

System Settings / Factory Default

Description	Command	Response
Query Device Version	GET VER	Command: GET VER<CR><LF> Return: VER 1.0 <CR><LF>
Factory Reset	RESET	Command: RESET<CR><LF> Return: RESET<CR><LF>
Reboot	REBOOT	Command: REBOOT<CR><LF> Return: REBOOT<CR><LF>

Technical Specifications

Input/Output Connections	
HDMI Inputs	Four (4) HDMI Type A Receptacle
HDMI Outputs	Two (2) HDMI Type A Receptacle
TCP/IP	One (1) 8P8C Port (Shielded RJ45 Female)
RS232	One (1) 3 pin Phoenix connector
Audio	- One (1) Analog L/R audio outputs, 3.5mm connectors - Two (2) Digital audio outputs, Toslink connectors
Supported Audio, Video, and Embedded Control	
Video Resolutions	Up to 4K@60Hz 4:4:4 8 bit
Maximum Passive HDMI Cable Distance	5m for 4k60 signals
Video Compliance	HDMI 2.0b and HDCP 2.2
Embedded HDMI Audio	Up to PCM 2.0/5.1/7.1, Dolby TrueHD, Dolby Atmos, DTS-HD Master Audio and DTS:X
De-embedded Audio- Digital and Analog	Analog L/R Out: PCM 2.0 Digital Toslink Out (De-embedded HDMI audio and ARC audio): Up to Dolby 5.1, DTS 5.1
Device Control Parameters	
Ethernet	100BaseT
RS232 Baud Rate	115200 baud
Chassis and Environmental	
Enclosure	Painted Aluminum
Dimensions (H x W x D)	246mm x 22mm x 100.2mm / 9.69" x 0.87" x 3.94"
Shipping Weight	0.62kg / 1.37lb
Operating Temperature	0° to +45° C (+32° to +113° F)
Operating Humidity	10% to 90%, Non-condensing
Storage Temperature	-20° to +70° C (-4° to +140° F)
Storage Humidity	10% to 90%, Non-condensing
Power, ESD, and Regulatory	
Power Supply	100V-240VAC / 50-60 Hz
Power Consumption	3.3W (Max.)
ESD Protection	8kV air, 4kV contact
Product Regulatory	FCC, CE, RoHS
Other	
Standard Warranty	5 years
Included Accessories	Quick Install Guide, IR Remote, (1) 3 Pin Phoenix Connector, Rack Mounting Clips with Screws, (1) AC power adapter with US, UK, EU and AU power plugs

Distances and picture quality may be affected by cable grade, cable quality, source and destination equipment, RF and electrical interference, and cable patches.

Thank you for your purchase.

For Technical Support please call our toll
free number at 800-530-8998 or email us at
supportlibav@libav.com

www.libav.com

Digitalinx is a brand of:

