

USER MANUAL



1x4 w/ HDMI Loop Out 18G HDBaseT Distribution Amp / Splitter DL-HD1X4-H2

PRODUCT OVERVIEW

The DigitalLink Series is a family of extension, routing, and switching products designed to allow digital signals to extend beyond their limitations. Liberty's latest addition, DL-HD1X4-H, is a complete kit that comes with one 4K HDMI to HDBaseT distribution amplifier plus four HDBaseT to HDMI receivers. This extender kit allows for one HDMI signal to be sent to four different locations up to 150 meters away while simultaneously passing the signal to a local display when using the loop output.

In addition to extending HDMI signals, enhanced features include:

Control: Pass bi-directional IR and RS232 control signals for communication to devices such as remote displays, media players, or the distribution amplifier.

Power: All receivers are powered using category cable, providing a clean and easy installation. The provided power supply for the distribution amplifier distributes the necessary power to all connected receivers.

Audio: Extract the HDMI audio from the source content to digital or analog at the distribution amplifier in addition to analog found on any receiver to connect to any audio amplifier or AV receiver.

Distance: Extend digital HDMI signals up to 120 meters away at resolutions reaching 4K2K@60Hz or 150 meters at 1080P@60Hz all from a signal CAT6/6a/7 cable.

Local Loop Output: Along with 4 HDBaseT outputs, the distribution amplifier is equipped with 1 local loop output for connecting to devices such as a local monitor for video preview or cascading the signal to another Liberty DL-HD1X4-H distribution amplifier increasing the outputs to 8 +1.

Advanced EDID Management: Take control of the EDID information that is being fed to the source device so the system configures itself in a manner that meets your display requirements without needing to best-match resolutions.

PACKAGE CONTENTS



(x1) User Manual



(x1) Transmitter, (x4) HDBaseT Receivers



(x5) IR Blaster Cables, (x5) IR Receiver Cables



(x5) 3-Pin Phoenix Connector, (x1) 5-Pin Phoenix Connectors

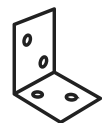

(x10) Mounting Ear



(x1) 24V/2.7A DC Locking Power Supply with US, EU, UK, AU Power Cords

TRANSMITTER PRODUCT BREAKDOWN

Front Panel

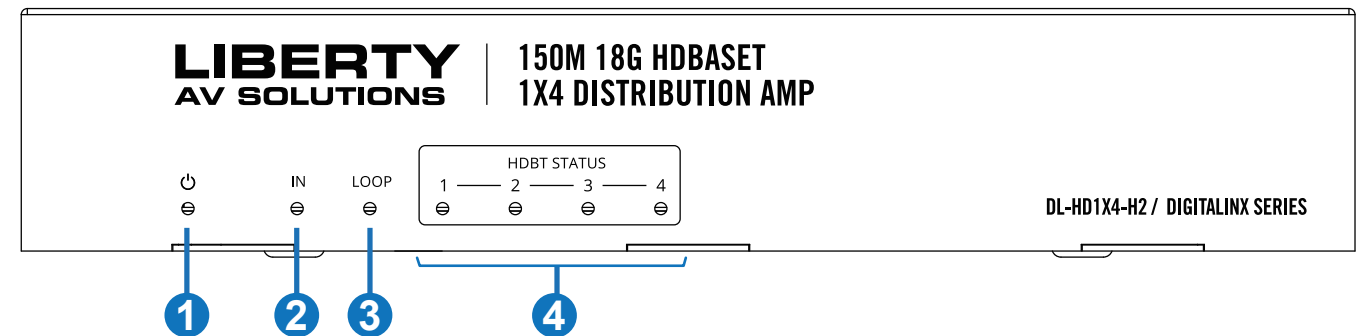

- 1. LED: POWER
- 2. LED: HDMI Input
- 3. LED: HDMI LOOP Output
- 4. LED: HDBaseT STATUS indicator for outputs 1-4

Rear Panel

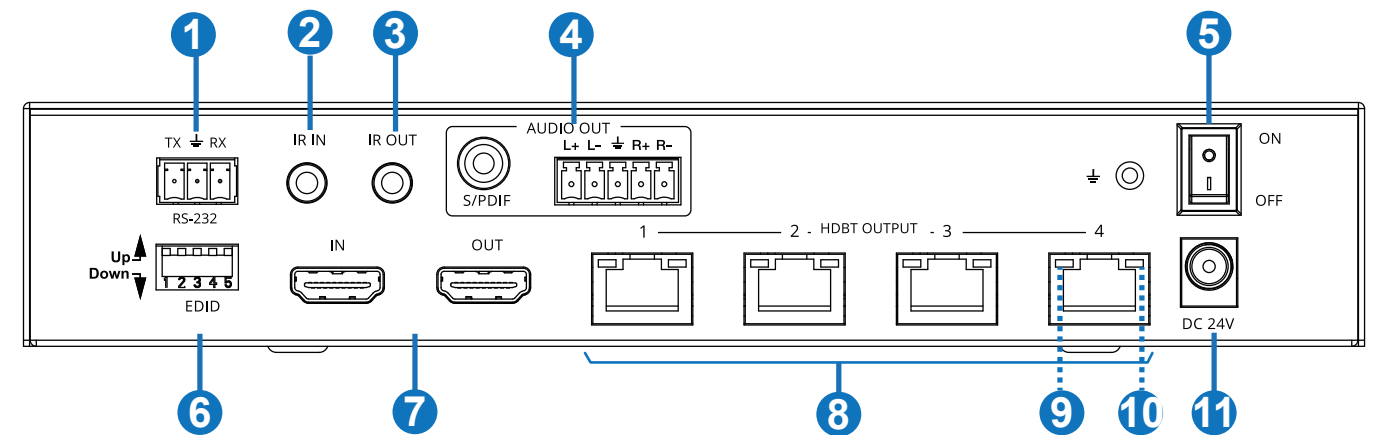

- 1. 3-Pin phoenix female port. Pass control signals to or from the main transmitter.
- 2. 3.5 female port. Connect IR BUD for sending signals to devices such as third-party displays.
- 3. 3.5 female port. Connect IR Blaster for receiving signals from party display locations.
- 4. Audio extraction ports: Female RCA port for S/PDIF and 5-Pin phoenix connector.
- 5. Rocker switcher for power ON/OFF
- 6. EDID DIP switch for managing EDID settings: See EDID configuration chart.
- 7. HDMI ports: Loop output and HDMI input
- 8. RJ45 female ports: HDBaseT signal extension
- 9. LED Link: Connection signal indicator lamp (green)
- 10. LED data: data signal indicator lamp (orange)
- 11. Power port: DC 24V using the provided power supply

RECEIVER PRODUCT BREAKDOWN

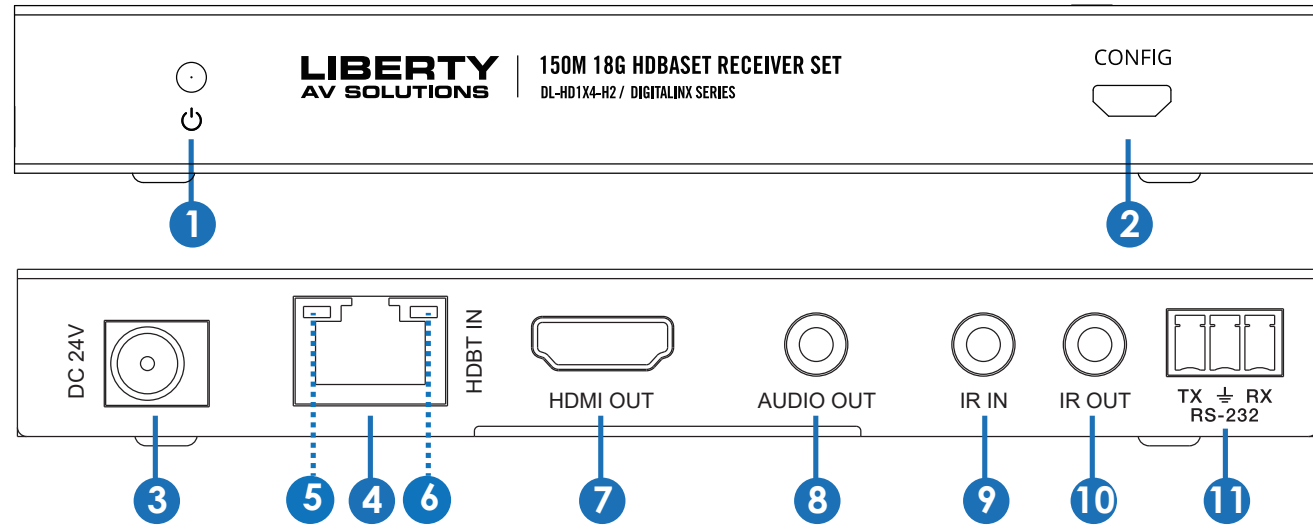

- 1. LED: Power indicator
- 2. Female micro USB port: *configuration
- 3. Female barrel port: DC 24V
- 4. RJ45 female port: HDBaseT input from main transmitter
- 5. LED: Connection Signal Indicator lamp (green)
- 6. LED: Data signal indicator lamp (orange)
- 7. Female HDMI port: Output to a display device
- 8. Female 3.5 jack: Audio output to a audio device
- 9. IR IN
- 10. IR OUT
- 11. 3-Pin phoenix female port. Pass control signals to or from the main transmitter.

Note for extending IR signals: When the angle between the IR receiver and the remote control is $\pm 45^\circ$, the transmission distance is 0-5 meters; when the angle between the IR receiver and the remote control is $\pm 90^\circ$, the transmission distance is 0-8 meters.

APPLICATION EXAMPLE

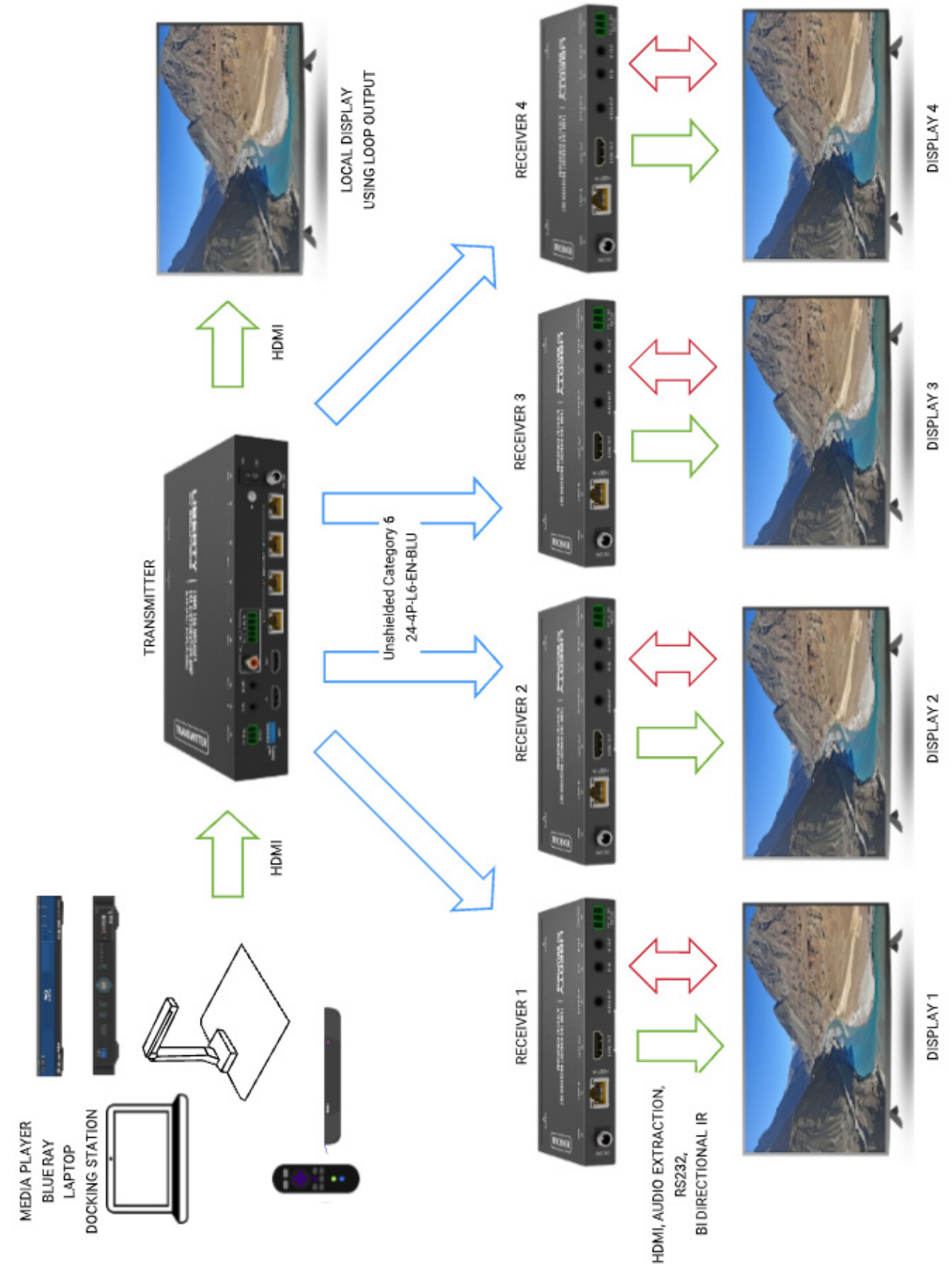

CONTROL PIN OUTS



IR Receiver



IR Blaster

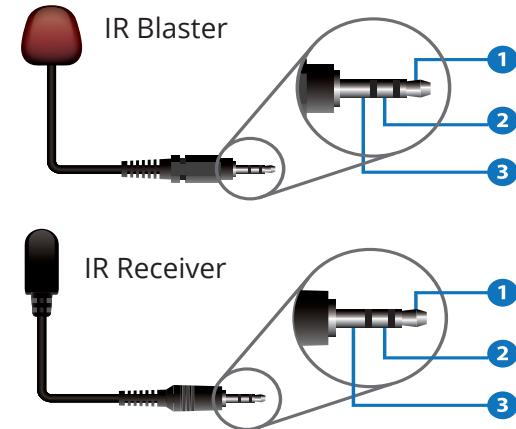

RS232 Pass-Through Pinout

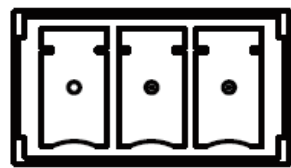

RS-232

Audio Pinout

L+ L- \perp R+ R-

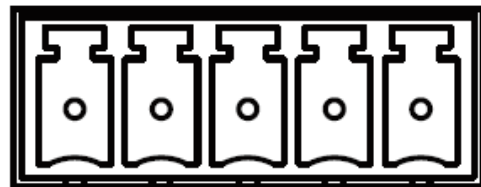

ASCII COMMANDS

ASCII Commands				
Serial port protocol. Baud rate: 115200, Data bits: 8bit, Stop bits:1, Check bit: 0				
x - Parameter 1 y - Parameter 2 ! - Delimiter				
Command Code	Function Description	Example	Feedback	Default Setting
Power				
s power z!	Power on/off the device, z=0~1 (z=0 power off, z=1 power on)	s power 1!	Power on System Initializing... Initialization Finished! FW version x.xx.xx	power on
r power!	Get current power state	r power!	power on/power off	N/A
s reboot!	Reboot the device	s reboot!	Reboot... System Initializing... Initialization Finished! FW version x.xx.xx	N/A
System Setup				
help!	List all commands	help!	N/A	N/A
r type!	Get device model	r type!	HDC-SPB14H150	N/A
r status!	Get device current status	r status!	Get the unit all status: power, in/out connection, EDID mode	N/A
r fw version!	Get Firmware version	r fw version!	MCU BOOT: Vx.xx.xx MCU APP: Vx.xx.xx	N/A
r link in!	Get the connection status of the input port	r link in!	HDMI IN: connect	N/A
r link out y!	Get the connection status of the y output port, y=0~5(0=all, 1~4=HDBT 1~4, 5 = loop out)	r link out 1!	HDMI loop out: connect HDBT output 1: connect	N/A
s reset!	Reset to factory defaults	s reset!	Reset to factory defaults System Initializing... Initialization Finished! FW version x.xx.xx	N/A

ASCII COMMANDS CONT.

Command Code	Function Description	Example	Feedback	Default Setting
Output Setting				
s HDMI stream z!	Set HDMI loop output stream on/off z=0~1 (0:disable, 1:enable)	s HDMI stream 1 !	Enable HDMI loop out stream Disable HDMI loop out stream	enable
s HDMI hdcp z!	Set HDMI loop output hdcp on/off z=0~1 (0:disable, 1:enable)	s HDMI hdcp 1!	Enable HDMI loop out hdcp Disable HDMI loop out hdcp	enable
s HDBT y hdcp z!	Set HDBT output y hdcp on/off, y=0~4(0=all) z=0~1(0:disable, 1:enable)	s HDBT 1 hdcp 1 ! s HDBT 0 hdcp 1 !	Enable HDBT output 1 hdcp Disable HDBT output 1 hdcp Enable HDBT all outputs hdcp Disable HDBT all outputs hdcp	enable
s HDBT y stream z!	Set HDBT output y stream on/off, y=0~4(0=all) z=0~1 (0:disable, 1:enable)	s HDBT 1 stream 1 ! s HDBT 0 stream 1 !	Enable HDBT output 1 stream Disable HDBT output 1 stream Enable HDBT all outputs stream Disable HDBT all outputs stream	enable
r HDMI stream!	Get HDMI loop out stream status	r HDMI stream!	Enable HDMI output stream	N/A
r HDMI hdcp!	Get HDMI loop out hdcp status	r HDMI hdcp!	Enable HDMI output hdcp	N/A
r HDBT y hdcp!	Get HDBT output y hdcp status, y=0~4(0=all)	r HDBT 1 hdcp!	Enable HDBT output 1 hdcp	N/A
r HDBT stream!	Get HDBT output y stream status, y=0~4(0=all)	r HDBT 1 stream!	Enable HDBT output 1 stream	N/A
RS-232 BYPASS Setting				
s rs232 bypass HDBT y!	Set RS-232 port connect to HDBT out1 Receiver RS-232 port, y=0~5(0=all, 1~4= HDBT out 1~4 5=NC)	s rs232 bypass HDBT 1!	RS-232 connect to HDBT OUT1 RS-232 not connect to HDBT OUT	y=0
r rs232 bypass!	Get RS-232 port connect to HDBT out receiver RS-232 port	r rs232 bypass!	RS-232 connect to HDBT OUT1 RS-232 connect to all HDBT OUT RS-232 not connect to HDBT OUT	N/A
s device baud w size x stop y parity z!	Set receiver control device COM port setting, w=2400, 4800,9600,19200,38400, 57600,115200, x=7,8 y=1,2, z=none, even,odd	s device baud 57600 size 8 stop 1 parity none!	receiver device COM port setting baudrate: 57600 data size :8, stop:1 parity: none	N/A
s rs232 time x!	set send RS232 command wait time x=200~5000ms	s rs232 time 200!	send RS-232 command wait time 200ms	200ms

ASCII COMMANDS CONT.

Command Code	Function Description	Example	Feedback	Default Setting
EDID Setting				
s EDID in from z!	Set input EDID from default EDID z, z=1~27 1, 1080p,Stereo Audio 2.0 2, 1080p,Dolby/DTS 5.1 3, 1080p,HD Audio 7.1 4, 1080i,Stereo Audio 2.0 5, 1080i,Dolby/DTS 5.1 6, 1080i,HD Audio 7.1 7, 3D,Stereo Audio 2.0 8, 3D,Dolby/DTS 5.1 9, 3D,HD Audio 7.1 10, 4K2K30_444, Stereo Audio 2.0 11, 4K2K30_444,Dolby/DTS 5.1 12, 4K2K30_444,HD Audio 7.1 13, 4K2K60_420, Stereo Audio 2.0 14, 4K2K60_420, Dolby/DTS 5.1 15, 4K2K60_420,HD Audio 7.1 16, 4K2K60_444, Stereo Audio 2.0 17, 4K2K60_444, Dolby/DTS 5.1 18, 4K2K60_444,HD Audio 7.1 19, 4K2K60_444, Stereo Audio 2.0 HDR 20, 4K2K60_444, Dolby/DTS 5.1 HDR 21, 4K2K60_444, HD Audio 7.1 HDR 22, copy from HDMI loop out 23, copy from HDBT output 1 24, copy from HDBT output 2 25, copy from HDBT output 3 26, copy from HDBT output 4 27, use user1 EDID	s EDID in from 1!	input EDID:1080p, Stereo Audio 2.0 Please toggle EDID dip switch to 00000!	1080p, Stereo Audio 2.0
s EDID user1 00 FF FF FF FF ...!	Set user1 EDID data	s EDID user1 00 ff ff ff ff ... !	user1 EDID data: 00 FF FF ...	N/A
r EDID user1!	Get user1 EDID data	r EDID user1!	user1 EDID data : 00 FF FF FF FF FF 00	N/A
r EDID in!	Get EDID status of the input	r EDID in!	input EDID: 4K2K60_444,Stereo Audio 2.0	N/A
r EDID in data!	Get the EDID data of the HDMI input	r EDID in data!	EDID data : 00 FF FF FF FF FF FF 00	N/A

CONFIGURATION SETTINGS

LED FUNCTION	STATUS
Status	When the receiver is powered on, the red LED light is on
Link	<ul style="list-style-type: none"> • Illuminating: Transmitter and receiver are in good connection status. • Flashing: Transmitter and receiver are in poor connection status. • Dark: Transmitter and receiver are not connected
Data	<ul style="list-style-type: none"> • Illuminating: HDMI signals with HDCP. • Flashing: HDMI signals without HDCP. • Dark: No HDMI signals.
Power	When the transmitter is powered on, the red LED light is on
HDMI	When the HDMI input port is active and the HDMI signal is detected, the green LED light is on

CONFIGURATION SETTINGS CONT.

DIP SWITCH	EDID STATUS DESCRIPTION
11111	1080P, Stereo Audio 2.0
11110	1080P, Dolby/DTS 5.1
11101	1080P, HD Audio 7.1
11110	1080I, Stereo Audio 2.0
11011	1080I, Dolby/DTS 5.1
11010	1080I, HD Audio 7.1
11001	1080P 3D, Stereo Audio 2.0
11000	1080P 3D, Dolby/DTS 5.1
10111	1080P 3D, HD Audio 7.1
10110	4K2K30Hz_444, Stereo Audio 2.0
10101	4K2K30Hz_444, Dolby/DTS 5.1
10100	4K2K30Hz_444, HD Audio 7.1
10011	4K2K60Hz_420, Stereo Audio 2.0
10010	4K2K60Hz_420, Dolby/DTS 5.1
10001	4K2K60Hz_420, HD Audio 7.1
10000	4K2K60Hz_444, Stereo Audio 2.0
01111	4K2K60Hz_444, Dolby/DTS 5.1
01110	4K2K60Hz_444, HD Audio 7.1
01101	4K2K60Hz_444, Stereo Audio 2.0 HDR
01100	4K2K60Hz_444, Dolby/DTS 5.1 HDR
01011	4K2K60Hz_444, HD Audio 7.1HDR
01010	COPY_FROM_LOOP OUT
01001	COPY_FROM_HDBT OUT1
01000	COPY_FROM_HDBT OUT2
00111	COPY_FROM_HDBT OUT3
00110	COPY_FROM_HDBT OUT4
00101	1080P, Stereo Audio 2.0
00100	1080P, Stereo Audio 2.0
00011	1080P, Stereo Audio 2.0
00010	1080P, Stereo Audio 2.0
00001	1080P, Stereo Audio 2.0
00000	PC control mode

TECHNICAL SPECIFICATIONS

Technical	
HDMI Compliance	HDMI 2.0b
HDCP Compliance	HDCP 2.2/1.x
Video Bandwidth	594MHz/18Gbps
Video Resolution	Up to 4k2k@60Hz 4:4:4
Color Depth	8-bit,10-bit,12-bit(1080p@60Hz) 8-bit (4K2K@60Hz YUV4:4:4) 8-bit,10-bit,12-bit(4K2K@60Hz YCbCr 4:2:2/4:2:0)
Color Space	RGB 4:4:4, YCbCr 4:4:4 / 4:2:2 / 4:2:0
HDR	Support HDR, HDR10+, HLG, Dolby vision
HDMI Audio Formats	LPCM 2.0/2.1/5.1/6.1/7.1, Dolby Digital, Dolby TrueHD, Dolby Digital Plus(DD+), DTS-ES, DTS HD Master, DTS HD-HRA, DTS-X
Coaxial Audio Formats	PCM2.0, Dolby Digital / Plus, DTS 2.0/5.1
Analog Audio Formats	PCM 2.0CH
ESD Protection	Human body model—±8kV (Air-gap discharge) & ±4kV (Contact discharge)
Connection	
Input	1×HDMI Type A (19-pin female)
Output	1×HDMI Type A (19-pin female) 4x HDBaseT OUT [RJ45] 1x Coaxial Audio OUT [RCA] 1x L/R Audio OUT [5-pin phoenix connector]
Control	1×RS-232 (3-pin phoenix connector) 1x EDID DIP switch [5-pin] 1x IR IN [3.5mm Stereo Mini-jack] 1x IR OUT [3.5mm Stereo Mini-jack]
Housing	Metal Enclosure
Silkscreen Color	Black
Dimensions	Transmitter: 220mm (W) × 130mm (D) × 40mm (H) Receiver: 140mm (W) × 65mm (D) × 18mm (H)
Weight	Transmitter: 853g Receiver: 246g
Power Supply	Input: AC100 - 240V 50/60Hz, Output: DC 24V/2.7A (US/EU standards, CE/FCC/UL certified)
Power Consumption	35W
Operation Temperature	0°C ~ 40°C / 32°F ~ 104°F
Storage Temperature	-20°C ~ 60°C / -4°F ~ 140°F
Relative Humidity	20~90% RH (non-condensing)

Thank you for your purchase.

For technical support please call our toll-free number at 800-530-8998 or email us at supportlibav@libav.com

LIBERTY
AV SOLUTIONS

www.libav.com 800-530-8998