



DIGITALINX
VALUE-ENGINEERED DIGITAL SOLUTIONS

DL-AS61U-H2 Owners Manual



Important Safety Instructions

- » Please completely read and verify you understand all instructions in this manual before operating this equipment.
- » Keep these instructions in a safe, accessible place for future reference.
- » Heed all warnings.
- » Follow all instructions.
- » Do not use this apparatus near water.
- » Clean only with a dry cloth.
- » Do not install near any heat sources such as radiators, heat registers, stoves, or other apparatus (including amplifiers) that produce heat.
- » Use only accessories specified or recommended by Intelix.
- » Explanation of graphical symbols:

◊ Lightning bolt/flash symbol: the lightning bolt/flash and arrowhead within an equilateral triangle symbol is intended to alert the user to the presence of uninsulated “dangerous voltage” within the product enclosure which may be of sufficient magnitude to constitute a risk of shock to a person or persons.



◊ Exclamation point symbol: the exclamation point within an equilateral triangle symbol is intended to alert the user to the presence of important operating and maintenance (servicing) instructions in the literature accompanying the product.



- » **WARNING: TO REDUCE THE RISK OF FIRE OR ELECTRIC SHOCK, DO NOT EXPOSE THIS APPARATUS TO RAIN OR MOISTURE AND OBJECTS FILLED WITH LIQUIDS, SUCH AS VASES, SHOULD NOT BE PLACED ON THIS APPARATUS.**
- » Use the mains plug to disconnect the apparatus from the mains.
- » **THE MAINS PLUG OF THE POWER CORD MUST REMAIN READILY ACCESSIBLE.**
- » Do not defeat the safety purpose polarized or grounding-type plug. A polarized plug has two blades with one wider than the other. A grounding-type plug has two blades and a third grounding prong. The wide blade or the third prong is provided for your safety. If the provided plug does not fit into your outlet, consult an electrician for replacement of your obsolete outlet. **Caution! To reduce the risk of electrical shock, grounding of the center pin of this plug must be maintained.**
- » Protect the power cord from being walked on or pinched particularly at the plugs, convenience receptacles, and the point where they exit from the apparatus.
- » Do not block the air ventilation openings. Only mount the equipment per Intelix’s instructions.
- » Use only with the cart, stand, table, or rack specified by Intelix or sold with the equipment. When/if a cart is used, use caution when moving the cart/equipment combination to avoid injury from tip-over.
- » Unplug this apparatus during lightning storms or when unused for long periods of time.
- » **Caution! Shock Hazard. Do not open the unit.**
- » Refer to qualified service personnel. Servicing is required when the apparatus has been damaged in any way, such as power supply cord or plug is damaged, liquid has been spilled or objects have fallen into the apparatus, the apparatus has been exposed to rain or moisture, does not operate normally, or has been dropped.



Table of Contents

Product Overview	4
Product Overview	4
Front and Rear Panels	5
Front Panel.....	5
Rear Panel.....	6
Installation Instructions	7
Mount the Matrix.....	7
Rack Mounting Instructions.....	7
Connect Sources.....	7
Connect Displays.....	7
Connect Audio (Optional).....	8
Connect RS232 Control (Optional).....	8
Connect External IR Control (Optional).....	8
Connect Ethernet (Web Browser) Control (Optional).....	9
Router Connection.....	9
Crossover Cable Connection.....	9
Web Browser Control.....	9
Applying Power.....	10
A/V Diagram	11
Web Browser Control / System Settings	12
Switcher Control.....	12
Connecting to Web Control Interface.....	12
Audio / Video Switching.....	13
Display Control.....	14
VGA Output Resolution.....	15
Audio ON/OFF Control.....	16
Testing RS232.....	17
Interface (Input Names).....	18
Access Settings.....	19
Network Settings.....	20
EDID Management	21
IR Remote Control	22
RS232 and TCP/IP Control	23
A/V Routing.....	23
A/V Switching Modes.....	24
Audio Control.....	24
CEC Display Control.....	25
System Commands.....	26
Technical Specifications	27

Product Overview

The DL-AS61U-H2 is a 6x1 HDMI 2.0b auto presentation switcher featuring three HDMI, one USB-C , one DisplayPort and one VGA input as well as one HDMI output. The first two HDMI inputs support MHL, the USB-C input support Display Port over Alternate Mode (ALT-DP). This switcher supports video resolutions up to 4Kx2K@60Hz 4:4:4 / 8 bit deep color as well as HDR and multichannel audio. In addition to passing native EDID information from the display to an input on the switcher, there are multiple built-in EDID settings to choose from to simplify an installation. The switcher can de-embed digital and/or analog audio for audio reinforcement purposes which is de-embedded from the HDMI output. The switchers functions can be controlled by built in web server / GUI, IR remote, RS232, IP or by front panel button operation. Integrated CEC support for display control via front panel buttons is built in.

When in auto-switch mode, the switcher will switch to an input as soon as a new source is connected. When the active source is removed, the switcher will select the first source on the lowest numbered input.

Product Contents

- DL-AS61U-H2 Auto Presentation Switcher
- Quick Install Guide
- (1) IR Receiver
- (1) IR Remote
- (1) 3 pin Phoenix Connector
- (1) 5 pin Phoenix Connector
- (1) DB9- 3 pin Phoenix RS232 breakout cable
- (1) DC12V 2A power supply with US, UK, EU and AU power adapters
- (2) Mounting Clips with 4 screws
- (4) Plastic Cushions

Front and Rear Panels

Front Panel

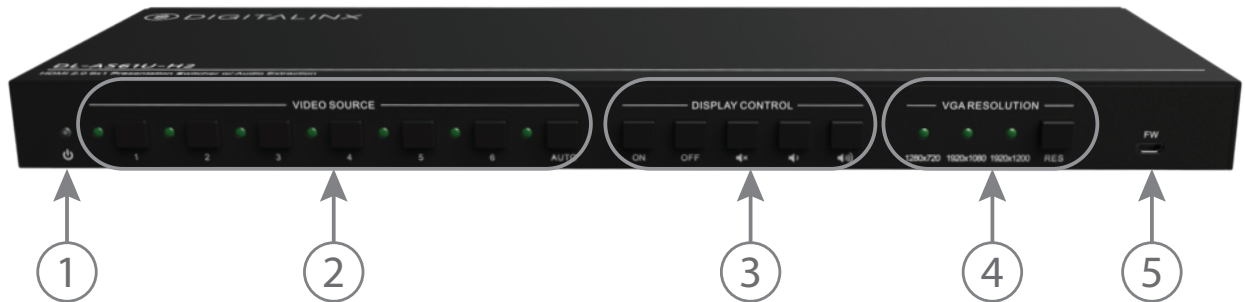

1. **POWER LED** - Illuminates solid RED when device is in standby mode, illuminates GREEN when device power is ON
2. **VIDEO SOURCE:**
 - *Buttons 1-6* - Video input front panel buttons, LEDs for the respective inputs will illuminate GREEN when selected
 - *AUTO Button* - Switches between auto and manual switch mode. Hold down for 3 seconds to enable /disable audio switch mode.
3. **DISPLAY CONTROL:**
 - *ON* - Press to turn display ON either by CEC or RS232
 - *OFF* - Press to turn display OFF either by CEC or RS232
 - *Volume Mute* - Press to mute display either by CEC or RS232
 - *Volume Down* - Press to turn display volume down either by CEC or RS232
 - *Volume Up* - Press to turn display volume up either by CEC or RS232
4. **VGA RESOLUTION:**
 - VGA resolution selection. Press *RES* repeatedly to set the preferred VGA resolution when the VGA input source is selected. Illuminates GREEN to indicate VGA resolution selected.
5. **FW** - USB port for firmware upgrade procedure

Rear Panel

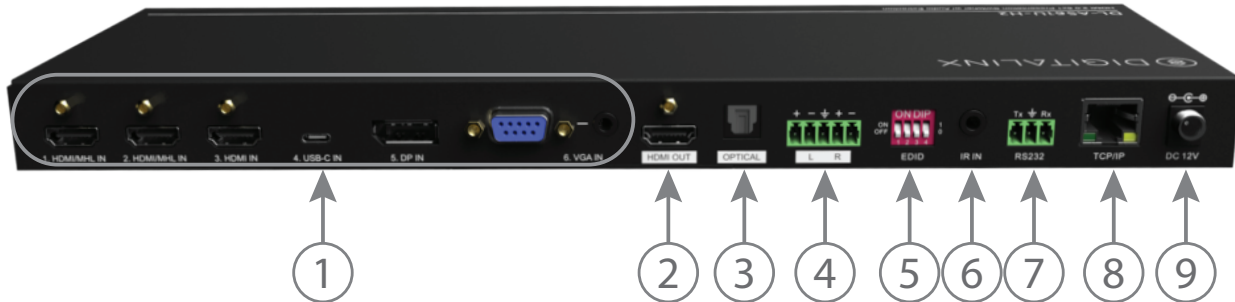

1. VIDEO INPUTS:

- Three HDMI input ports
- One USB- C USB input port
- One DisplayPort input port
- One VGA input port with 3.5mm audio input

2. **HDMI OUT** - HDMI output for connecting to TV display

3. **OPTICAL** - Toslink output for digital audio output

4. **L/R AUDIO** - 5 pin phoenix; balanced left and right analog audio output

5. **EDID** - Dip switch setting for EDID management

6. **IR IN** - 3.5mm connector to connect IR receiver to control switcher by IR remote

7. **RS232** - 3 pin phoenix; output port for connection display or 3rd party control

8. **TCP/IP** - RJ45; Networking port

9. **DC 24V** - Locking power supply port

Installation Instructions

Mount the Matrix

At least 2 inches of free air space is required on both sides of the DL-AS61U-H2 for proper side ventilation. Avoid mounting the DL-AS61U-H2 near a power amplifier or any other source of significant heat.

Rack Mounting Instructions

Remove the four screws on both sides of the DL-AS61U-H2, then attach the supplied mounting clips to the DL-AS61U-H2 for surface or rack mounting..

Connect Sources

Connect source devices to the HDMI, Display Port or VGA inputs. When using HDMI cables for source inputs, use a High Speed HDMI cable that is less than or equal to 1.5 meters in length for 4k60 signals and 5 meters for 1080p signals. For source devices that are further away, it is highly recommended to install an HDMI extender such as the Digitalinx DL-HD70, DL-HDE100, DL-HDE100-H2 or the DL-HD2100.

When connecting a source device to the USB-C input using a USB-C cable, be sure the USB-C cable is capable of supporting video and is no longer than 2 meters (6.6') in total length. The DL-AS61U-H2 USB-C input supports ALT-DP mode for video, to ensure a laptop is compatible with the DL-AS61U-H2 check the laptops capability of supporting this mode.

Note that not all laptops will support video (ALT-DP).

Connect Displays

Connect the display device to the HDMI output using a High Speed HDMI cable that is less than or equal to 1.5 meters in length for 4k60 signals and 5 meters for 1080p signals. For display device that is further away, it is highly recommended to install an HDMI extender such as the Digitalinx DL-HD70, DL-HDE100, DL-HDE100-H2 or the DL-HD2100.

Connect Audio (Optional)

Connect an audio amplifier to the audio output of the DL-AS61U-H2, the switcher features a left and right balanced audio output and a digital TOSLINK output.

Connect RS232 Control (Optional)

Connect a control system to the DL-AS61U-H2 via RS232 for switcher control.

RS232 Wiring

Connect the system controller RX signal to TX on the DL-AS61U-H2, then connect the controllers TX signal to RX on the DL-AS61U-H2.

RS232 Settings:

- 9600 baud
- 8 Data Bits
- 1 Stop Bit
- Parity = none

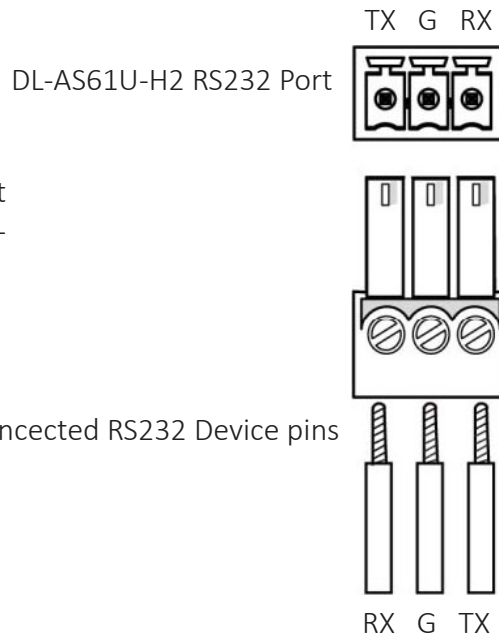

Connect External IR Control (Optional)

If IR extension is required, connect the TRS 3.5 mm plug IR RX to the matrix IR EXT port, ensuring the IR receiver eye is placed in clear view of the handset used to control.

Connect Ethernet (Web Browser) Control (Optional)

The DL-AS61U-H2 may be controlled via Ethernet through a web browser interface.

The TCP/IP port requires a standard straight-through Category 5 or greater cable with the TIA/EIA-568B crimp pattern for optimal operation.

The default settings for the TCP/IP port are:
IP address: 192.168.0.178

Connect the Ethernet cable between to the matrix and a router with a straight-through cable or between the matrix and a computer with a crossover cable.

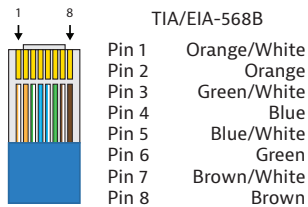

Router Connection

1. Configure the router to use the same IP range as the matrix, such as 192.168.0.1.
2. Connect the computer to the router.
3. Connect the DL-AS61U-H2 to the router

Crossover Cable Connection

1. Configure the computer to use the same network prefix as the IP address assigned to the matrix. *For example, the IP address of the matrix is 192.168.0.178. Set the computer to use a static IP address within the same network range, such as 192.168.0.42.*
2. Connect the network crossover cable to the computer and to the TCP/IP port on the DL-AS61U-H2

Crossover Cable Pinout

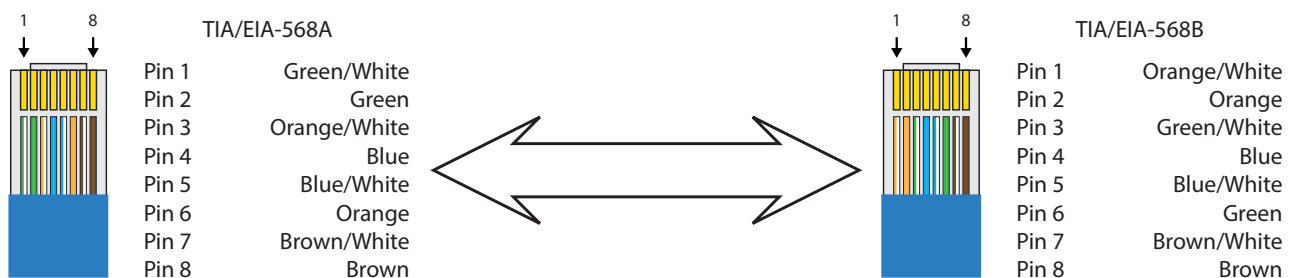

Web Browser Control

The DL-AS61U-H2 includes a web portal to allow control of the matrix via a standard web browser. The IP address is the same address that is used for TCP/IP control.

Applying Power

Connect the included power supply to the DL-AS61U-H2 and lock the power supply to the power connector by twisting the locking collar clockwise.

A/V Diagram

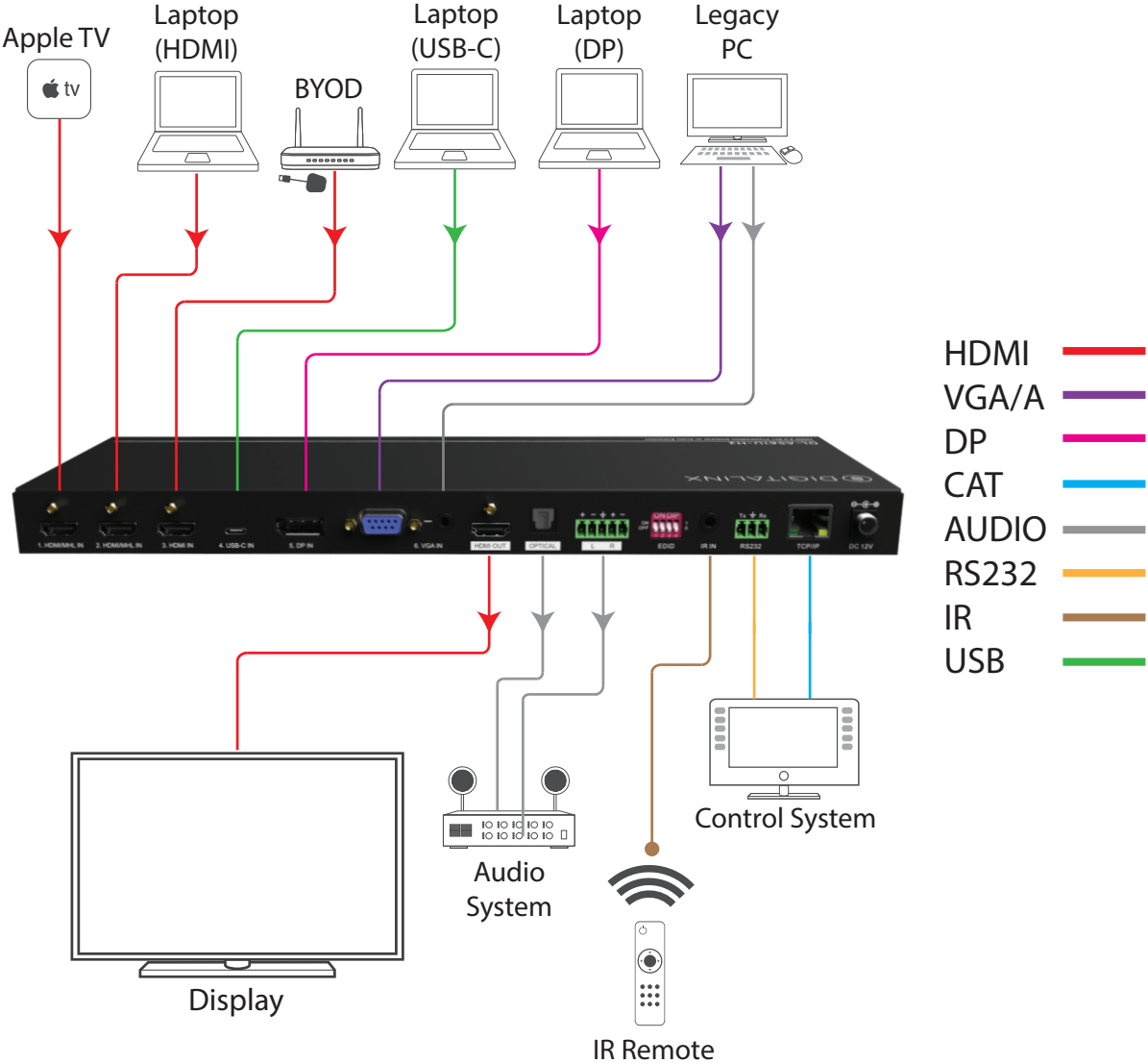

Web Browser Control / System Settings

Switcher Control

Connecting to Web Control Interface

Open a web browser and type in IP address of the DL-AS61U-H2. The default IP address is 192.168.0.178. Be sure the computer you are using to connect to the DL-AS61U-H2 is in the same IP range.

The login screen will appear. The default user name and password is *admin*

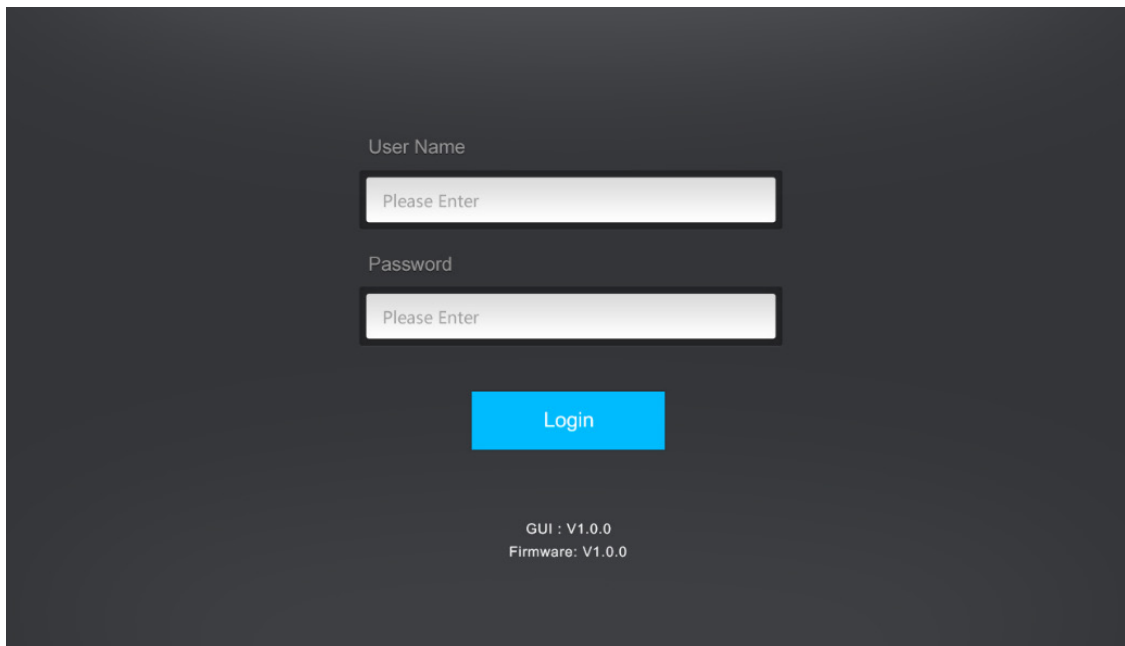

Audio / Video Switching

The *SWITCHING* menu allows you to route A/V signals to the HDMI output of the switcher as well as enable / disable auto switching mode. By default the DL-AS61U-H2 is set to auto switching mode.

To switch the video route, check the 1-6 buttons corresponding to the desired input, only one input can be selected at one time.

To enable / disable auto switching mode, check the *AUTO* button.

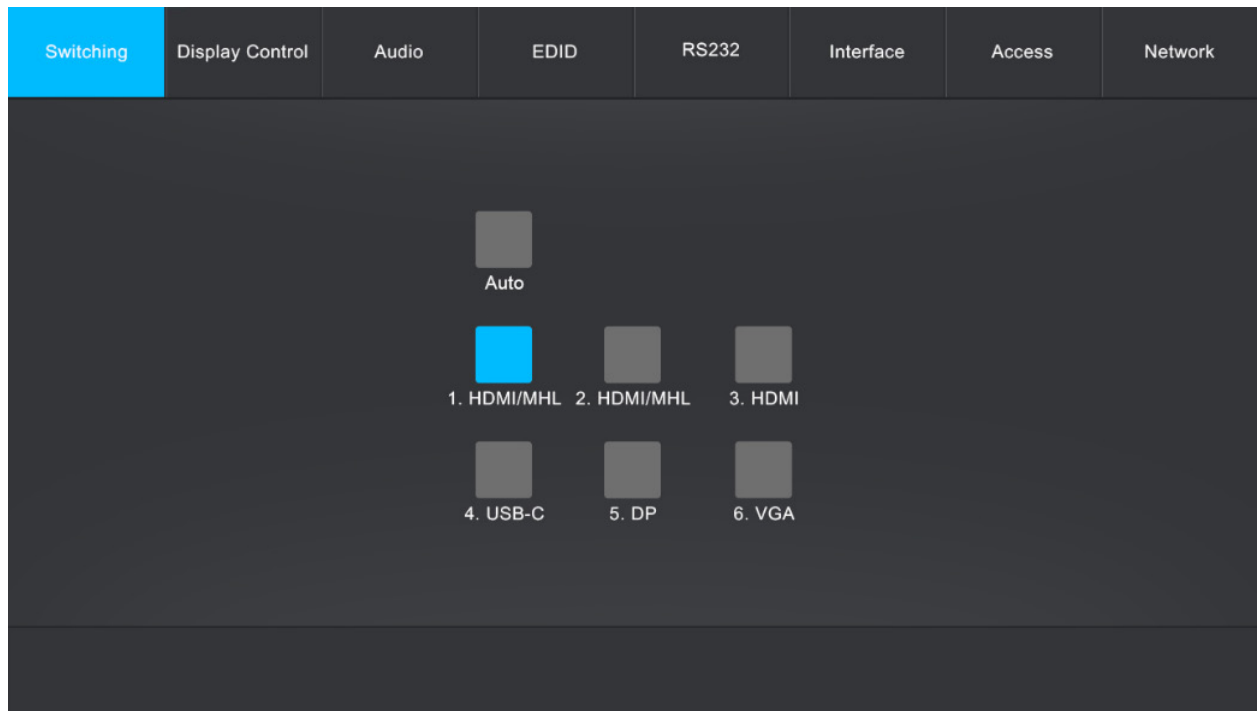

Display Control

The *Display Control* menu allows you to control the connected display via CEC as well as adjust the VGA output resolution.

To control the display using CEC via the connected HDMI cable, make sure that a CEC compatible TV display is used. CEC settings for displays must also be turned ON, consult the TV displays owners manual on how to engage or turn ON CEC control.

NOTE: Not all CEC compatible displays will be compatible with volume control, it is a best practice to test the displays CEC compatibility with the DL-AS61U-H2 first before deploying into an application.

Use the *ON / OFF / MUTE / VOLUME - / VOLUME +* to control the displays ON/OFF and volume status.

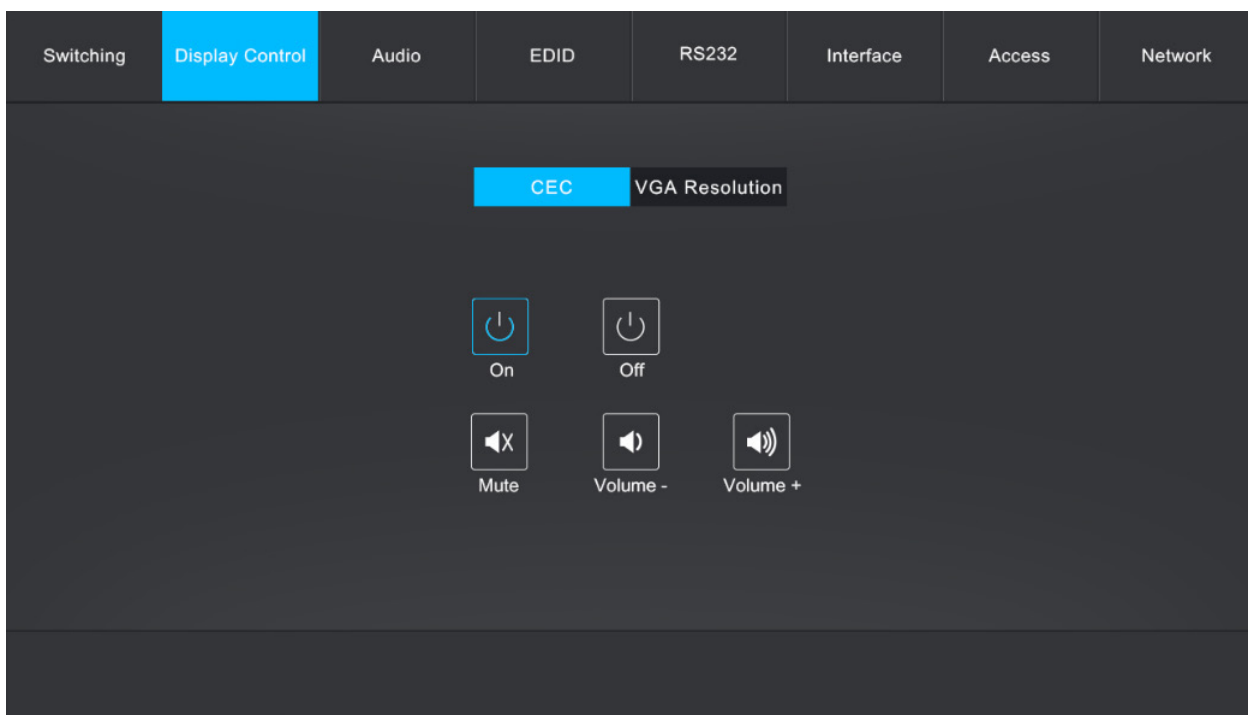

VGA Output Resolution

To adjust the VGA output resolution, click on the *VGA RESOLUTION* tab in the *Display Control* Menu. Then choose the desired resolution, then click *Confirm*.

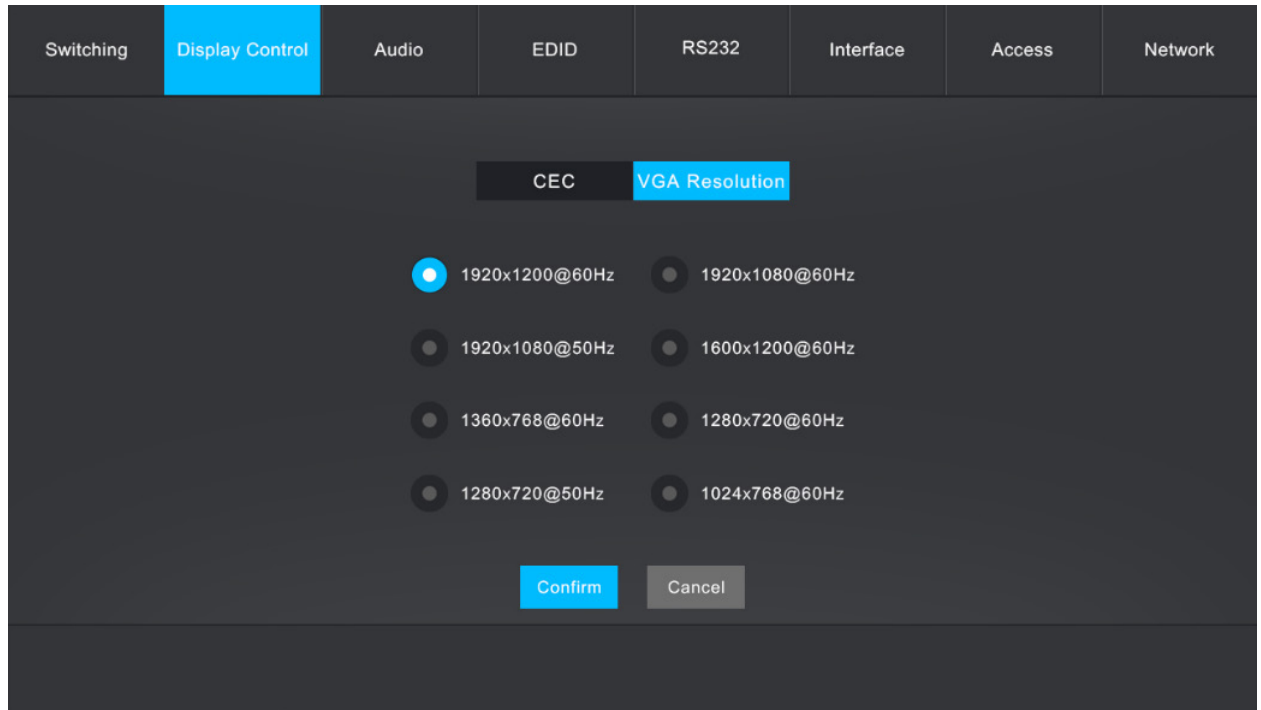

Audio ON/OFF Control

The *EDID* menu allows you to select a desired EDID table to used for source compatibility communication.

To select a pre-defined EDID setting, choose the desired EDID and then click *Confirm*.

To use a user-defined EDID setting, check on either *User -defined 1-4* option, load the EDID (.bin) file from your computer, then click *Apply*.

If EDID table fails, the switcher will default to 1080p.

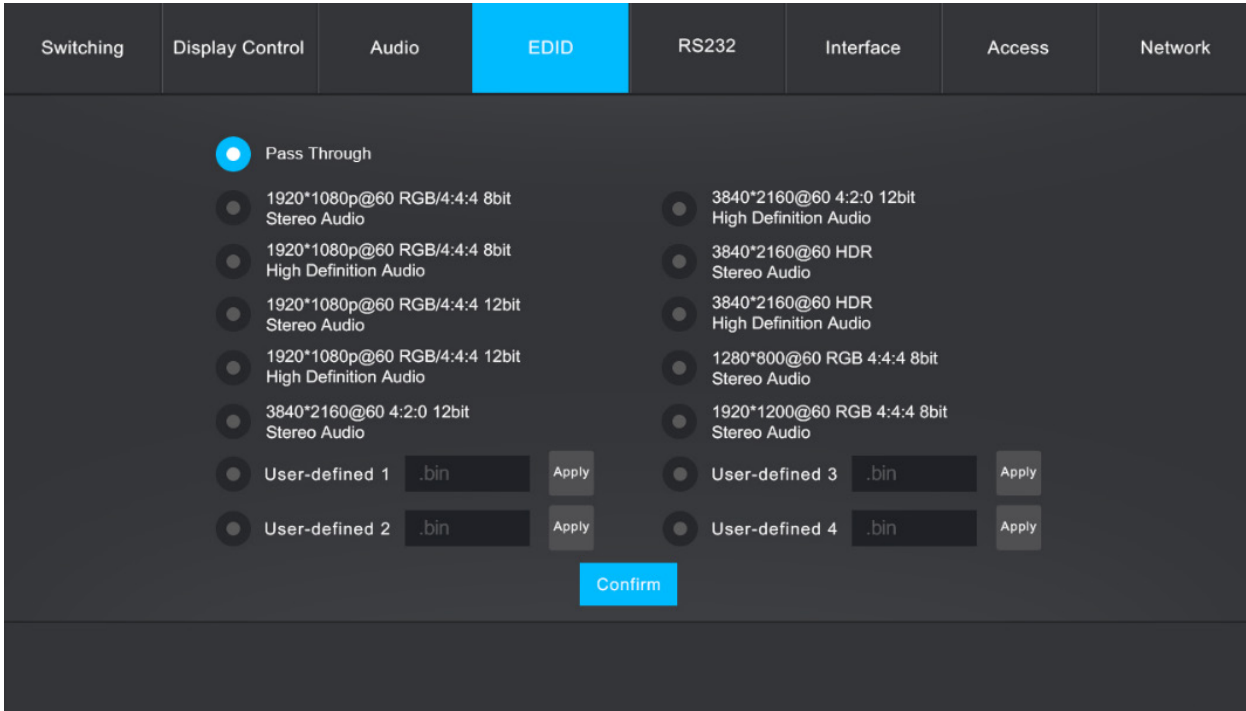

To use the GUI EDID feature in this tab you must select all 4 EDID dip switches on the back of the DL-AS61U-H2 to the ON (1) position for all pre-defined options in the EDID menu above.

To use the User Defined EDID options in the GUI, you must adjust the EDID dip switches to the following positions for their respective option:

- User-Defined 1: 1011 (ON, OFF, ON, ON)
- User-Defined 2: 1100 (ON, ON, OFF, OFF)
- User-Defined 3: 1101 (ON, ON, OFF, ON)
- User-Defined 4: 1110 (ON, ON, ON, OFF)

Testing RS232

The *RS232* menu allows you to test RS232 command strings through the RS232 serial port output on the switcher connected to a 3rd party device such as a display or projector.

Check either *ASCII* or *HEX* formatted string to send to RS232 output, choose the desired *Baud Rate* setting, choose the desired *Command Ending* terminator, then enter the command string under the *Command* field. Then click *Send* to test the command.

To test HEX formatted commands use the following syntax format: XX XX XX XX (XX = hex character). Example; the display ON command you are testing is 0xA1 0xA2 0xA3 0xA4 0xA5, enter in A1 A2 A3 A4 A5 into the *Command* field to test, the 0x identifiers is not necessary.

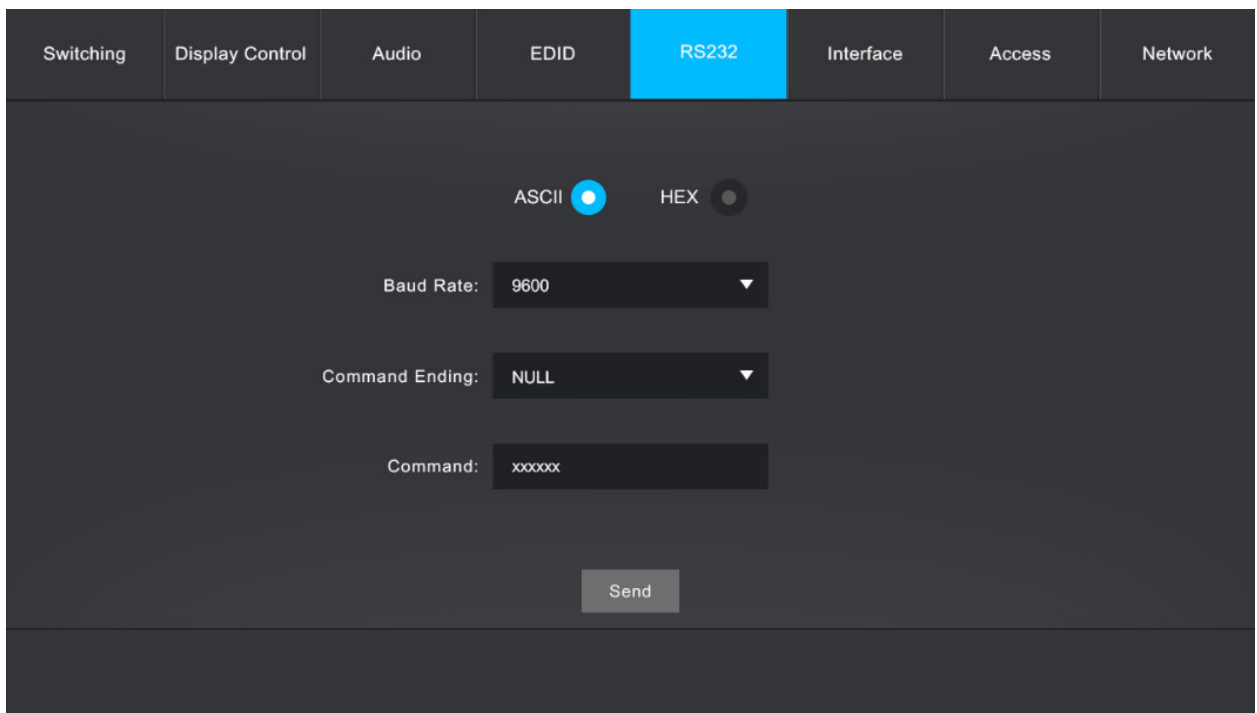

The screenshot shows a web interface with a navigation bar at the top containing the following tabs: Switching, Display Control, Audio, EDID, RS232 (highlighted in blue), Interface, Access, and Network. Below the navigation bar, the RS232 configuration section is displayed on a dark background. It includes two radio buttons for 'ASCII' (selected) and 'HEX'. Below these are three dropdown menus: 'Baud Rate' set to '9600', 'Command Ending' set to 'NULL', and 'Command' set to 'xxxxxx'. A 'Send' button is located at the bottom of the configuration area.

Interface (Input Names)

The *Interface* menu allows you to define the video input names as well as assign a title to GUI control

To add a title to the GUI control, enter in the desired name under *Title Bar Label*: then click *Confirm* to save

To add user defined names to the video inputs, enter in the name for each input: then click *Confirm* to save

The screenshot shows a web interface with a dark background. At the top, there is a navigation bar with tabs: Switching, Display Control, Audio, EDID, RS232, Interface (highlighted in blue), Access, and Network. Below the tabs, the 'Interface' configuration page is displayed. It features a 'Title Bar Label:' label followed by a dark input field. Underneath is the 'Button Labels:' section, which contains six numbered input fields arranged in two columns: 1. HDMI/MHL, 2. HDMI/MHL, 3. HDMI, 4. USB-C, 5. DP, and 6. VGA. At the bottom of the configuration area, there are two buttons: 'Confirm' (highlighted in blue) and 'Cancel' (grey).

Access Settings

The *Access* menu allows you to change the password credentials for the admin login as well as lock / unlock the front panel buttons of the DL-AS61U-H2.

To change the password for the admin login, enter in the desired password then click *Confirm*

To enable / disable front panel lock control, check on either the ON or OFF button under *Front Panel Lock*

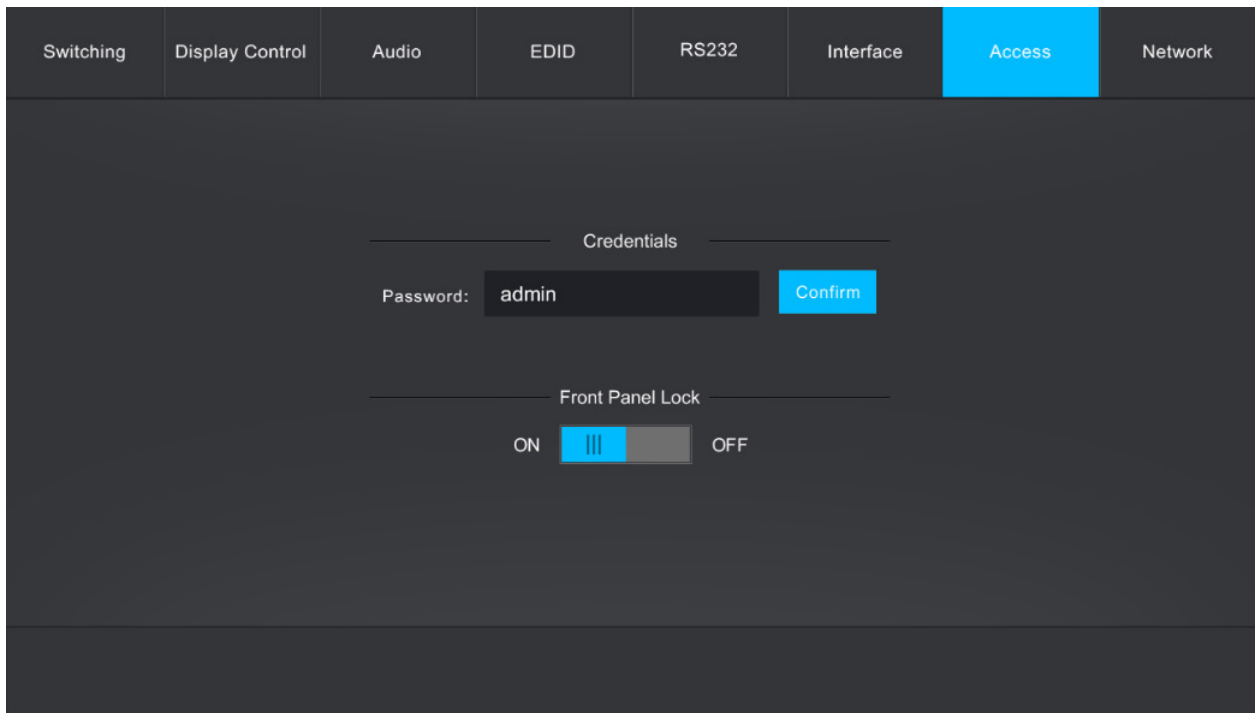

The screenshot displays the web interface for the DL-AS61U-H2 device. At the top, a navigation bar contains several tabs: Switching, Display Control, Audio, EDID, RS232, Interface, Access (highlighted in blue), and Network. Below the navigation bar, the 'Access' section is visible. It is divided into two sub-sections: 'Credentials' and 'Front Panel Lock'. In the 'Credentials' section, there is a 'Password:' label followed by a text input field containing the text 'admin'. To the right of the input field is a blue 'Confirm' button. In the 'Front Panel Lock' section, there are two buttons: 'ON' and 'OFF'. The 'ON' button is highlighted in blue, while the 'OFF' button is greyed out.

Network Settings

The *Network* menu allows you to set the IP address mode to either Static or DHCP, by default the DL-AS61U-H2 is set to Static mode with a pre-defined IP address of 192.168.0.178 / subnet 255.255.255.0 and gateway set to 192.168.0.1

Check either the *DHCP* or *Static* mode to change IP modes. If using a Static IP address enter in the IP address, subnet and gateway. Then click *Confirm*. You will need to reboot the switch for the new network settings to take place.

The screenshot shows a web interface for network configuration. At the top, there is a navigation bar with tabs: Switching, Display Control, Audio, EDID, RS232, Interface, Access, and Network (which is highlighted in blue). Below the navigation bar, the MAC Address is displayed as 44-33-4C-C9-35-12. There are two radio buttons for IP mode: DHCP (unselected) and Static IP (selected). Below the radio buttons, there are three input fields: IP Address (192.168.0.178), Subnet Mask (255.255.255.0), and Gateway (192.168.0.1). At the bottom of the form, there is a blue Confirm button.

EDID Management

EDID (Extended Display Identification Data) is data generated from a connected display in an HDMI system to communicate the resolution capabilities to a connected video source. The DL-AS61U-H2 features an EDID copy mode that can be used to copy EDID settings from the display connected to the HDMI output of the switcher so they can be communicated to the sources connected to the video inputs. If preset EDID tables are preferred rather than using EDID copy, use the dipswitch settings below for the desired resolution and audio settings.

When in the down position, the switch represents “0” or OFF, when the switch position in the up position it represents “1” or ON.

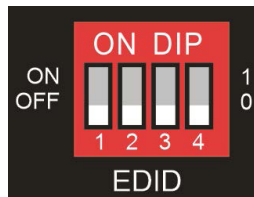

EDID Setting	Position 1	Position 2	Position 3	Position 4
EDID Copy (default)	0	0	0	0
1080p@60Hz RGB 4:4:4 8bit, Stereo Audio	0	0	0	1
1080p@60Hz RGB 4:4:4 8bit, Multi channel Audio	0	0	1	0
1080p@60Hz RGB 4:4:4 12bit, Stereo Audio	0	0	1	1
1080p@60Hz RGB 4:4:4 12bit, Multi channel Audio	0	1	0	0
3840x2160@30Hz RGB 4:2:0 12bit, Stereo Audio	0	1	0	1
3840x2160@30Hz RGB 4:2:0 12bit, Multi channel Audio	0	1	1	0
3840x2160@60Hz HDR, Stereo Audio	0	1	1	1
3840x2160@60Hz HDR, Multi channel Audio	1	0	0	0
1280x800@60Hz RGB 4:4:4 8bit, Stereo Audio	1	0	0	1
1920x1200@60Hz RGB 4:4:4 8bit, Stereo Audio	1	0	1	0

Note: When using EDID copy, if EDID fails the EDID will default to 1080p.

IR Remote Control

The DL-AS61U-H2 includes a IR remote which performs routing functions available on the front panel of the switcher. When using the remote control locally, i.e., pointed directly at the switcher.



1. **Enter or exit standby power button**
2. **Video input selection buttons and AUTO switching mode button** (toggles between enable and disable auto switching)
3. **Source device control buttons**
4. **VGA resolution selection buttons**
5. **Display device control buttons**

RS232 and TCP/IP Control

RS232 Settings: 9600 baud, 8 Data bits, 1 Stop bit, Parity = None

TCP/IP Settings: User defined IP address (default IP address:192.168.0.178), port 4001

There are no spaces between any of the characters in the command string. The commands are case sensitive.

Note: In order to use the switching commands below, the switcher must be in manual switching mode only. System will not respond to switching commands in auto switching mode.

A/V Routing

Description	Command	Examples
Switch to HDMI input 1	HDMI1 .	<p><i>Command:</i> HDMI1 .</p> <p><i>Response:</i> HDMI OUT SWITCH TO 1!<CR><LF></p>
Switch to HDMI input 2	HDMI2 .	<p><i>Command:</i> HDMI2 .</p> <p><i>Response:</i> HDMI OUT SWITCH TO 2!<CR><LF></p>
Switch to HDMI input 3	HDMI3 .	<p><i>Command:</i> HDMI3 .</p> <p><i>Response:</i> HDMI OUT SWITCH TO 3!<CR><LF></p>
Switch to HDMI input 4 (USB-C input)	HDMI4 .	<p><i>Command:</i> HDMI4 .</p> <p><i>Response:</i> HDMI OUT SWITCH TO 4!<CR><LF></p>
Switch to HDMI input 5 (Display Port input)	HDMI5 .	<p><i>Command:</i> HDMI5 .</p> <p><i>Response:</i> HDMI OUT SWITCH TO 5!<CR><LF></p>
Switch to HDMI input 6 (VGA input)	HDMI6 .	<p><i>Command:</i> HDMI6 .</p> <p><i>Response:</i> HDMI OUT SWITCH TO 6!<CR><LF></p>

A/V Switching Modes

Description	Command	Examples
Enable auto switching mode	HDMIA.	<p>Command: HDMIA.</p> <p>Response: HDMI OUT SWITCH TO AUTO MODE!<CR><LF></p>
Enable manual switching mode	HDMIM.	<p>Command: HDMIM.</p> <p>Response: HDMI OUT SWITCH TO MANUAL MODE!<CR><LF></p>

Audio Control

NOTE: By default the audio de-embedded outputs follow the video route. Below are commands you can use to breakaway audio so it can be separated and routed independently from video.

Description	Command	Examples
Turns the stereo analog L/R audio output ON	IISON.	<p>Command: IISON</p> <p>Response: IIS OUT ON!<CR><LF></p>
Turns the stereo analog L/R audio output OFF	IISOFF.	<p>Command: IISOFF</p> <p>Response: IIS OUT OFF!<CR><LF></p>
Turns the TOSLINK digital audio output ON	SPDIFON.	<p>Command: SPDIFON.</p> <p>Response: SPDIF OUT ON!<CR><LF></p>
Turns the TOSLINK digital audio output OFF	SPDIFOFF.	<p>Command: SPDIFOFF.</p> <p>Response: SPDIF OUT OFF!<CR><LF></p>

CEC Display Control

The following commands can be used to control the display connected to the HDMI output of the DL-AS61U-H2 via CEC.

To use this feature a CEC compatible TV display must be used and the feature must be turned ON in the display menu properties.

NOTE: Not all CEC display control functions below may be supported by a TV display manufacturer. Test CEC display control first before deploying to be sure what your TV will support.

Description	Command	Examples
Turns connected display ON	TVON .	<i>Command:</i> TVON. <i>Response:</i> CEC TV POWER ON!<CR><LF>
Turns connected display OFF	TVOFF .	<i>Command:</i> TVOFF. <i>Response:</i> CEC TV POWER OFF!<CR><LF>
Increases volume by 1 value	TVVOL+ .	<i>Command:</i> TVVOL+ <i>Response:</i> CEC TV VOLUME INCREASE!<CR><LF>
Decreases volume by 1 value	TVVOL- .	<i>Command:</i> TVVOL- . <i>Response:</i> CEC TV VOLUME DECREASE!<CR><LF>
Mutes / unmutes audio	TVMUTE .	<i>Command:</i> TVMUTE. <i>Response:</i> CEC TV VOLUME MUTE/ UNMUTE!<CR><LF>

System Commands

Description	Command	Examples
Turns switcher ON	POWON .	<p><i>Command:</i> POWON.</p> <p><i>Response:</i> POWER ON!<CR><LF></p>
Turns switcher OFF	POWOFF .	<p><i>Command:</i> POWOFF.</p> <p><i>Response:</i> AUDIOMP hdmi1 audioout1<CR><LF></p>
Restores the matrix to factory defaults	RST .	<p><i>Command:</i> RST.</p> <p><i>Response:</i> FACTORY DEFAULT! SCU61E VERSION V1.0.0 POWER ON! FRONT PANEL UNLOCK! HDMI OUT SWITCH TO AUTO MODE! HDMI OUT SWITCH TO 1! DIP0000! DIP EDID0000! SPDIF OUT ON! IIS OUT ON!</p>
Front panel button LOCK	LOCK .	<p><i>Command:</i> LOCK.</p> <p><i>Response:</i> FRONT PANEL LOCKED!<CR><LF></p>
Front panel button UNLOCK	UNLOCK .	<p><i>Command:</i> UNLOCK.</p> <p><i>Response:</i> FRONT PANEL UNLOCK!<CR><LF></p>

Technical Specifications

Video	
Video Inputs	(2) HDMI/MHL, (1) HDMI, (1) USB-C, (1) DisplayPort, (1) VGA
Video Input Connector	(3) HDMI Type A Female, (1) USB-C, (1) DisplayPort, (1) 15-pin VGA
Input Video Signal	HDMI for HDMI input, ALT-DP Mode for USB-C, DP Version 1.2 for DisplayPort input, MHL Version 2.2 for MHL
HDMI Input Resolution Support	Up to 3840 x 2160 @60Hz / 4:4:4 / 8 bit deep color for HDMI
MHL Input Resolution Support	Up to 10809 @60Hz
USB C Input Resolution Support	Up to 3840 x 2160 @30Hz / 4:4:4 / 8 bit deep color for HDMI
DisplayPort Input Resolution Support	Up to 3840 x 2160 @60Hz / 4:4:4 / 8 bit deep color for HDMI
VGA Input Resolution Support	Up to 1920x1200 @50/60Hz
Video Output	(1) HDMI
Video Output Connector	(1) HDMI type A
Output Resolution Support	Up to 3840 x 2160 @60Hz / 4:4:4 / 8 bit deep color
Standards	Compliant with HDMI 2.0b, HDCP 2.2 and CEC
Bandwidth	18Gbps
Audio	
Supported output formats	<i>Analog output:</i> PCM <i>HDMI Embedded:</i> LPCM 7.1 audio, Dolby Atmos®, Dolby® TrueHD, Dolby Digital® Plus, DTS: X™, and DTS-HD® Master Audio™ pass-through <i>DisplayPort Audio Format:</i> 8 channels LPCM, up to 24bit 192Khz, AC3, DTS <i>Toslink Output:</i> PCM, Dolby Digital, DTS, DTS-HD
Audio Output	Balanced Stereo Analog
Audio Output Connector	<i>Analog output:</i> 5 pin Phoenix <i>Digital output:</i> Optical / Toslink
Audio Output Impedance	70 Ohms
Frequency Response	20Hz-20KHz
Control	
Control Port / Connector	(1) 3 Pin Phoenix for RS232, (1) RJ45 for TCP/IP control, (1) IR input port for IR receiver
Chassis and Environmental	
Dimensions (WxHxD)	342 mm x 26 mm x 115 mm (13.5 in x 1 in x 4.5 in)
Shipping Weight	620g (1.4 lbs.)
Operating Temperature	0° to +55° C (+32° to +131° F)
Operating Humidity	10% to 90%, Non-condensing
Storage Temperature	-20° to +70° C (+14° to +158° F)
Storage Humidity	10% to 90%, Non-condensing
Power, ESD, and Regulatory	
Power Supply Input	100V-240VAC / 50-60 Hz
Power Supply Output	12VDC / 2A
Power Consumption	10 watts (max)
ESD Protection	15kV
Product Regulatory	FCC, CE, RoHS
Power Supply Regulatory	CE, RoHS
Other	
Standard Warranty	5 years
Included Accessories	Quick Install Guide, Power Supply with US, UK, EU and AU power plug, (1) IR Receiver, (1) IR Remote, (1) 3-pin to DB9 RS232 Cable, (1) 5 pin Phoenix connector, (1) 3 pin Phoenix connector, (2) Mounting clips with screws and (4) plastic cushions

Thank you for your purchase.

For Technical Support please call our toll
free number at 800-530-8998 or email us at
supportlibav@libav.com

www.libav.com

Digitalinx is a brand of:



LIBERTY®
AV SOLUTIONS
A SUBSIDIARY OF WESCO DISTRIBUTION, INC.