

Liberty

DL-1H1A1UCWP-H3 Owners Manual

Digitalinx Series Uncompressed 4K60 HDMI / USB-B + USB-C Auto- Switching Wall Plate extension set over HDBaseT 3.0

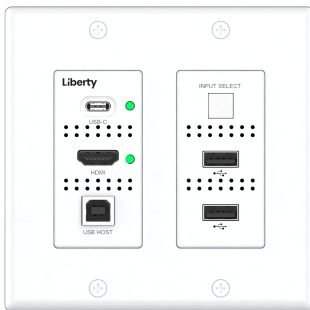

User Manual

Thank you for purchasing this product

For optimum performance and safety, please read these instructions carefully before connecting, operating or adjusting this product. Please keep this manual for future reference.

Surge protection device recommended

This product contains sensitive electrical components that may be damaged by electrical spikes, surges, electric shock, lighting strikes, etc. Use of surge protection systems is highly recommended in order to protect and extend the life of your equipment.

Caution

The product requires the use of UTP connectors. Please connect in direct interconnection method and do not cross connect.

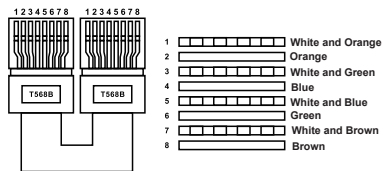

Direct Interconnection Method

Table of Contents

1. Introduction.....	1
2. Features.....	1
3. Package Contents.....	2
4. Specifications.....	2
5. Operation Controls and Functions.....	4
5.1 Transmitter Panel.....	4
5.2 Receiver Panel.....	6
6. Dimensions of the Wall Plate.....	7
7. API Commands.....	8
8. Application Example.....	10

1. Introduction

This wall plate extension set is based on HDBaseT 3.0 VS300R, with a standard US 2GANG Decora design. Uncompressed video signal transmission distance can be extended up to 230ft/70m for 4K@30Hz, or 131ft/40m for 4K@60Hz over a single CAT6A/7 (F/FTP) cable as well as power and USB2.0 data.

The transmitter features 1x HDMI input, 1x USB-C (40W charging), 1x USB-B host and 2x USB-A client ports. USB-C passes ALT-DP Audio/Video, USB 2.0 Data, and power. Ensure all connected USB-C sources support ALT-DP mode prior to use. The receiver features 1x HDMI output, 2x USB-A client ports, 1x Audio de-embedding port.

This product supports RS-232 signal pass-through, EDID management and 24V bidirectional PoC (power over cable) function.

2. Features

- ☆ Compliant with HDMI 2.0b and HDCP 2.2, 18Gbps video bandwidth
- ☆ HDBaseT Chip VS300R based design, standard US 2GANG Decora design
- ☆ Uncompressed video signal transmission distance can be extended up to 230ft/70m for 4K@30Hz, or 131ft/40m for 4K@60Hz over a single CAT6A/7 (F/FTP) cable
- ☆ HDR, HDR10, HDR10+, Dolby Vision LLM, HLG pass-through
- ☆ TX features 1x HDMI Input, 1x USB-C, 1x USB-B host and 2x USB-A client ports
- ☆ RX features 1x HDMI output, 2x USB-A client ports, 1x Audio de-embedding port
- ☆ TX/RX USB-A client ports VBUS on or off triggered by USB host connection / Removal
- ☆ Input supports auto switching and manual switching modes
- ☆ Auto switching supports HDMI 5V or signal detect selection
- ☆ Support bidirectional PoC (power over cable) function, RX powers TX. Additionally, TX features with second power port and once it connected with a power supply, the USB-C will provide charging power up to 40 watts
- ☆ Support EDID management on TX
- ☆ Support auto down scaling on RX
- ☆ Support RS-232 signal pass-through
- ☆ Each USB-A port provides power up to 5V/500mA

3. Package Contents

- ① 1x HDMI + USB-C Wall Plate Transmitter
- ② 1x HDBaseT Receiver
- ③ 1x Faceplate
- ④ 1x 2pin-3.81mm Phoenix Connector (male)
- ⑤ 2x 3pin-3.81mm Phoenix Connector (male)
- ⑥ 1x 24V/2.7A Desktop Power Supply with 2pin-3.81mm Male Phoenix Connector (for TX)
- ⑦ 1x 24V/1A Multinational Locking Power Supply (for RX)
- ⑧ 4x American Standard Slotted Semi-countersunk Head Screws (6#-32)
- ⑨ 4x American 6 # -32 Screw
- ⑩ 4x Machine Screw (M3.5*12)
- ⑪ 2x Mounting Ear
- ⑫ 1x User Manual

4. Specifications

Technical	
HDMI Compliance	HDMI 2.0b
HDCP Compliance	HDCP 2.2
USB Compliance	USB 2.0
Video Bandwidth	18Gbps
Video Resolution	Up to 4K@60Hz 4:4:4
Color Space	RGB, YCbCr 4:4:4, YCbCr 4:2:2, YCbCr 4:2:0
Color Depth	8/10/12bit
HDR	HDR, HDR10, HDR10+, Dolby Vision, HLG
Audio Formats	HDMI/USB-C/HDBT: LPCM 2/5.1/7.1CH, Dolby Digital/Plus/EX, Dolby True HD, DTS, DTS-EX, DTS-96/24, DTS High Res, DTS-HD Master Audio, DSD 3.5mm Analog Audio: LPCM 2CH
Transmission Distance	4K60: 131ft/40m [CAT6A/7 (F/FTP)] 4K30: 230ft/70m [CAT6A/7 (F/FTP)]
ESD Protection	Human body model — ±8kV (Air-gap discharge) & ±4kV (Contact discharge)

Connection			
Transmitter	Input: 1 x HDMI IN [Type A, 19-pin female] 1 x USB-C IN [USB Type C, 24-pin female] Output: 1 x HDBT OUT [RJ45, 8-pin female] Control: 1 x RS-232 [3pin-3.81mm phoenix connector] 1 x F/W [Micro USB, 5-pin female] 1 x USB HOST [USB Type B, 4-pin female] 2 x USB Devices [USB Type A, 4-pin female]		
Receiver	Input: 1 x HDBT IN [RJ45, 8-pin female] Output: 1 x HDMI OUT [Type A, 19-pin female] 1 x AUDIO OUT [3.5mm audio jack] Control: 1 x RS-232 [3pin-3.81mm phoenix connector] 1 x FIRMWARE [Micro USB, 5-pin female] 2 x USB HUB [USB Type A, 4-pin female]		
Mechanical			
Housing	Metal Enclosure		
Color	Black		
Dimensions	Wall plate: 91.8mm [W] x 47mm [D] x 104.7mm [H] Faceplate: 115.9mm [W] x 6.5mm [D] x 114.3mm [H] Receiver: 200mm [W] x 98mm [D] x 23mm [H]		
Weight	Transmitter: 225g, Receiver: 308g		
Power Supply	Input: AC 100 - 240V 50/60Hz Output: TX: DC 24V/2.75A; RX: DC 24V/1A (US/EU standard, CE/FCC/UL certified)		
Power Consumption (Max)	TX+RX (full load): 55W TX (no load): 2.72W		
Operating Temperature	32 - 104°F / 0 - 40°C		
Storage Temperature	-4 - 140°F / -20 - 60°C		
Relative Humidity	20 - 90% RH (no condensation)		
Resolution / Cable Length	4K60 - Feet / Meters	4K24 - Feet / Meters	1080P60 - Feet / Meters
HDMI IN / OUT	26ft / 8M	39ft / 12M	50ft / 15M
The use of "Premium High Speed HDMI" cable is highly recommended.			

5. Operation Controls and Functions

5.1 Transmitter Panel

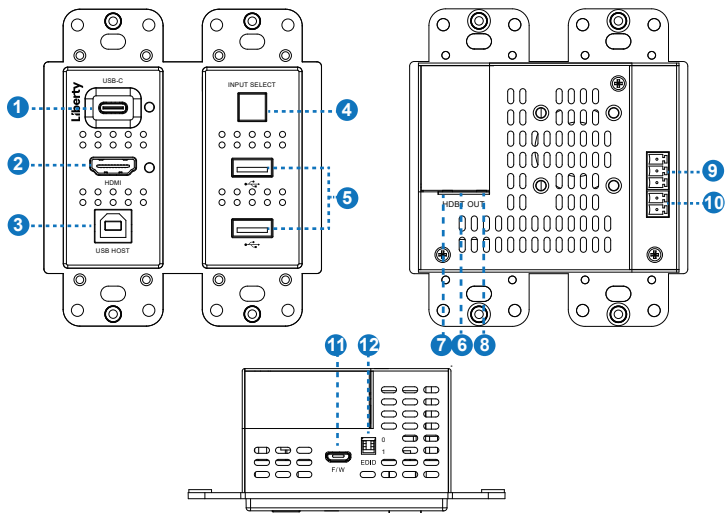

No.	Name	Function Description
1	USB-C port & LED (Green)	<p>USB-C port with following three functions:</p> <ol style="list-style-type: none"> (1) USB-C video signal input port, connected to source device. (2) USB-C HOST port. When the USB-C port of TX is selected as the video signal input channel, the USB-C port can be used as a USB 2.0 signal transmission port simultaneously. (3) USB-C charging. Only when TX is connected to the included/optional 24V/ 2.7A power supply, the USB-C port can provide 40W charging power for external USB-C devices. When TX is not connected to the power supply and relies on RX PoC, the USB-C port can not provide charging function. <p>USB-C LED: When the USB-C port of TX is selected as the video signal input channel, the USB-C LED will be on.</p>

No.	Name	Function Description
2	HDMI port & LED (Green)	<p>HDMI port: HDMI signal input port, connected to HDMI source device. When the HDMI port of TX is selected as the input channel, the USB 2.0 signal can only be output through the USB HOST port.</p> <p>HDMI LED: When the HDMI port of TX is selected as the input channel, the HDMI LED will be on.</p>
3	USB HOST port	USB HOST port, connected to PC for extending the USB ports of TX or RX.
4	INPUT SELECT button	Input signal channel select button, used to switch HDMI / USB-C input signal.
5	USB Devices ports	Two USB extension ports, connected to mouse, keyboard, USB Flash Drive or other USB devices.
6	HDBT OUT port	HDBaseT output port, connected to the HDBT IN port of Receiver with a CAT 6A/7 (F/FTP) cable. It is used for various signals pass-through.
7	Link Signal Indicator (Green)	<ul style="list-style-type: none"> ▪ Light on: Transmitter and Receiver are in good connection status. ▪ Light flashing: Transmitter and Receiver are in poor connection status. ▪ Light off: Transmitter and Receiver are not connected.
8	Data Signal Indicator (Orange)	<ul style="list-style-type: none"> ▪ Light on: There is video signal transmission with HDCP encryption. ▪ Light flashing: There is video signal transmission without HDCP encryption. ▪ Light off: There is no video signal transmission.
9	RS-232 port	<p>RS-232 serial port with following two functions:</p> <p>(1) Pass through external serial port commands to the RS-232 port of the HDBaseT Receiver.</p> <p>(2) Receive API commands to control the wall plate.</p>
10	DC 24V	Power input port, connected to DC 24V/2.7A power supply.
11	F/W port	Micro USB port, which can be used for firmware upgrade and API command transmission.
12	EDID DIP switch	<p>Used for EDID setting:</p> <p>00- Copy display's EDID (as factory default)</p> <p>01- 4K30 4:4:4 2CH</p> <p>10- 1080p60 4:4:4 2CH</p> <p>11- 1200p60 4:4:4 2CH</p>

5.2 Receiver Panel

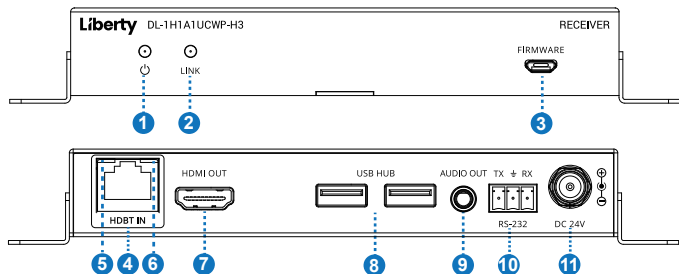

No.	Name	Function Description
1	Power LED	Red LED indicates that the Receiver is powered on.
2	LINK LED (Green)	<ul style="list-style-type: none"> Light on: Transmitter and Receiver are in good connection status. Light flashing: Transmitter and Receiver are in poor connection status. Light off: Transmitter and Receiver are not connected.
3	FIRMWARE port	Micro USB port, which can be used for firmware upgrade and API command transmission.
4	HDBT IN port	HDBaseT input port, connected to the HDBT OUT port of Transmitter with a CAT6A/7 (F/FTP) cable. It is used for various signals pass-through.
5	Data Signal Indicator (Orange)	<ul style="list-style-type: none"> Light on: There is video signal transmission with HDCP encryption. Light flashing: There is video signal transmission without HDCP encryption. Light off: There is no video signal transmission.
6	Link Signal Indicator (Green)	<ul style="list-style-type: none"> Light on: Transmitter and Receiver are in good connection status. Light flashing: Transmitter and Receiver are in poor connection status. Light off: Transmitter and Receiver are not connected.
7	HDMI OUT port	HDMI signal output port, connected to HDMI display device, such as TV or monitor.
8	USB HUB ports	Two USB extension ports, connected to mouse, keyboard, USB Flash Drive or other USB devices.
9	AUDIO OUT port	Analog audio output port, which is used for audio de-embedding output.

No.	Name	Function Description
10	RS-232 port	RS-232 serial port with following two functions: (1) Pass through external serial port commands to the RS-232 port of the HDBaseT Receiver. (2) Receive API commands to control the wall plate.
11	DC 24V	Power input port, connected to DC 24V/1A power supply.

6. Dimensions of the Wall Plate

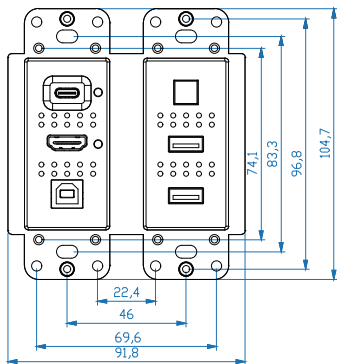

Front Panel

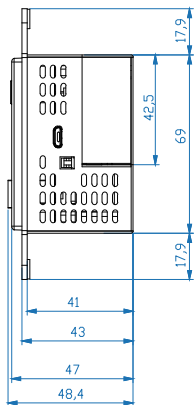

Side Panel

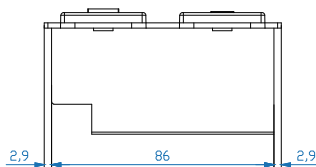

Top Panel

Unit: mm

7. API Commands

The product also supports API commands control. Connect the RS-232 port of the product to a PC with a 3-pin phoenix connector cable, or connect the FW port of the product to a PC with a Micro USB cable. Then, open a serial command tool on PC to send ASCII commands to control the product. The ASCII commands list about the product is shown as below.

ASCII Commands				
RS-232 Communication Protocol Baud rate: 115200; Data bit: 8; Stop bit: 1; Parity bit: none. The end mark of command is "<CR><LF>".				
Command Code	Function Description	Example	Feedback	Default
Help	Get the list of all commands	Help	===== DL-1H1A1UCWP-H3 Help Info FW Version: TX 1.0.0 RX 1.0.0 Help Get the list of all commands GetFirmwareVersion Get the firmware version =====	
GetFirmwareVersion	Get the firmware version	GetFirmwareVersion	TX 1.0.0 RX 1.0.0	
FactoryReset	Reset to factory defaults	FactoryReset	Sure to RESET to default settings? Type "Yes" after next prompt to confirm...	
GetStatus	Get the current status	GetStatus	Input: USB-C Video: 1920x1080p60 Audio: 48K PCM 2CH HDCP: 1.4 USB Host: Connected HDBT Link: ON HDBT Signal: ON EDID: DIP_00 (Copy display's EDID)	
SetTxInput x	Set TX input video x = USBC, HDMI, AVMUTE, OFF	SetTxInput USBC	TxInput USBC	USBC
GetTxInput	Get TX input status	GetTxInput	USBC	
SetTxAutoSwitchOn x	Enable/Disable TX auto-switching mode x = ON, OFF	SetTxAutoSwitchOn ON	TxAutoSwitchOn ON	ON
GetTxAutoSwitchOn	Get TX auto-switching mode status	GetTxAutoSwitchOn	ON	

Command Code	Function Description	Example	Feedback	Default
SetTxAutoSwitchMode x	Set TX auto-switching mode x = 0: 5V detection 1: signal detection	SetTxAutoSwitchMode 1	TxAutoSwitchMode 1	1: signal detection
GetTxAutoSwitchMode	Get TX auto-switching mode status	GetTxAutoSwitchMode	1	
SetRxDownScale x	Set RX downscaling mode, x= AUTO: automatically according to display's capability ON: force 4K to 1080p OFF: bypass video	SetRxDownScale AUTO	RxDownScale AUTO	AUTO
GetRxDownScale	Get RX downscaling mode	GetRxDownScale	AUTO	
SetRxAudioMute x	Enable/Disable RX de-embedding audio mute x = ON, OFF	SetRxAudioMute ON	RxAudioMute ON	OFF
GetRxAudioMute	Get RX de-embedding audio mute status	GetRxAudioMute	OFF	
SetEdid x To y	Set input ports EDID x = USB-C or HDMI port y = 00 - EDID dipswitch (default) 01 - 1920x1080@60 8bit Stereo 02 - WUXGA 1920x1200 03 - 1920x1080@60 8bit High Definition Audio 04 - 3840x2160@60Hz 4:2:0 Deep Color Stereo Audio 05 - 3840x2160@60Hz Deep Color Stereo Audio 06 - 3840x2160@30Hz 8bit Stereo Audio 07 - 3840x2160@60Hz Deep Color High Definition Audio 08 - 3840x2160@60Hz Deep Color HDR LPCM 6CH 09 - copy EDID from RX HDMI output 10 - User Defined 1 11 - User Defined 2	SetEdid USBC To 00	Edid USBC To 00	00

Command Code	Function Description	Example	Feedback	Default
GetEdid x	Get input ports EDID x = USBC, HDMI	GetEdid USBC	00	
GetEdidData x	Get input ports EDID data x = USBC, HDMI	GetEdidData USBC	USBC EDID <00 FF FF FF....>	
SetUserEdid x <y>	Set user defined EDID x = 1 (User Defined 1) x = 2 (User Defined 2) y = 00 FF FF FF (y is 256 bytes EDID data)	SetUserEdid 1 <00 FF FF FF....>	UserEdid 1 is loaded	
GetUserEdid x	Get user defined EDID x = 1 (User Defined 1) x = 2 (User Defined 2)	GetUserEdid 1	UserEdid 1 <00 FF FF FF....>	
SetHdbtUpdate	Set Micro USB (UART) to HDBT UART for FW update	SetHdbtUpdate	HdbtUpdate	

8. Application Example

